

TIP29, A, B, C (NPN), TIP30, A, B, C (PNP)

Complementary Silicon Plastic Power Transistors

Designed for use in general purpose amplifier and switching applications. Compact TO-220 package.

Features

- These Devices are Pb-Free and are RoHS Compliant*

MAXIMUM RATINGS

Rating	Symbol	Value	Unit
Collector – Emitter Voltage TIP29G, TIP30G TIP29AG, TIP30AG TIP29BG, TIP30BG TIP29CG, TIP30CG	V_{CEO}	40 60 80 100	Vdc
Collector – Base Voltage TIP29G, TIP30G TIP29AG, TIP30AG TIP29BG, TIP30BG TIP29CG, TIP30CG	V_{CB}	40 60 80 100	Vdc
Emitter – Base Voltage	V_{EB}	5.0	Vdc
Collector Current – Continuous	I_C	1.0	Adc
Collector Current – Peak	I_{CM}	3.0	Adc
Base Current	I_B	0.4	Adc
Total Power Dissipation @ $T_C = 25^\circ\text{C}$ Derate above 25°C	P_D	30 0.24	W W/ $^\circ\text{C}$
Total Power Dissipation @ $T_A = 25^\circ\text{C}$ Derate above 25°C	P_D	2.0 0.016	W W/ $^\circ\text{C}$
Unclamped Inductive Load Energy (Note 1)	E	32	mJ
Operating and Storage Junction Temperature Range	T_J, T_{stg}	-65 to +150	$^\circ\text{C}$

Stresses exceeding those listed in the Maximum Ratings table may damage the device. If any of these limits are exceeded, device functionality should not be assumed, damage may occur and reliability may be affected.

1. This rating based on testing with $L_C = 20\text{ mH}$, $R_{BE} = 100\ \Omega$, $V_{CC} = 10\text{ V}$, $I_C = 1.8\text{ A}$, P.R.F = 10 Hz

THERMAL CHARACTERISTICS

Characteristic	Symbol	Max	Unit
Thermal Resistance, Junction-to-Ambient	$R_{\theta JA}$	62.5	$^\circ\text{C/W}$
Thermal Resistance, Junction-to-Case	$R_{\theta JC}$	4.167	$^\circ\text{C/W}$

*For additional information on our Pb-Free strategy and soldering details, please download the ON Semiconductor Soldering and Mounting Techniques Reference Manual, SOLDERRM/D.



ON Semiconductor®

www.onsemi.com

1 AMPERE POWER TRANSISTORS COMPLEMENTARY SILICON 40, 60, 80, 100 VOLTS, 80 WATTS

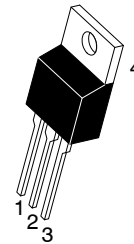
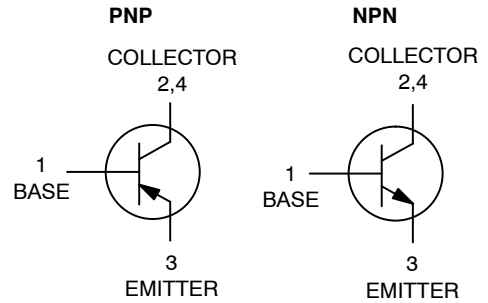

TO-220
CASE 221A
STYLE 1

MARKING DIAGRAM

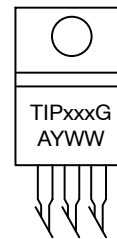

TIPxxx = Device Code:
29, 29A, 29B, 29C
30, 30A, 30B, 30C
A = Assembly Location
Y = Year
WW = Work Week
G = Pb-Free Package

ORDERING INFORMATION

See detailed ordering and shipping information on page 4 of this data sheet.

TIP29, A, B, C (NPN), TIP30, A, B, C (PNP)

ELECTRICAL CHARACTERISTICS (T_C = 25°C unless otherwise noted)

Characteristic	Symbol	Min	Max	Unit
OFF CHARACTERISTICS				
Collector-Emitter Sustaining Voltage (I _C = 30 mAdc, I _B = 0) (Note 2) TIP29G, TIP30G TIP29AG, TIP30AG TIP29BG, TIP30BG TIP29CG, TIP30CG	V _{CEO(sus)}	40 60 80 100	- - - -	Vdc
Collector Cutoff Current (V _{CE} = 30 Vdc, I _B = 0) TIP29G, TIP29AG, TIP30G, TIP30AG (V _{CE} = 60 Vdc, I _B = 0) TIP29BG, TIP29CG, TIP30BG, TIP30CG	I _{CEO}	- -	0.3 0.3	mAdc
Collector Cutoff Current (V _{CE} = 40 Vdc, V _{EB} = 0) TIP29G, TIP30G (V _{CE} = 60 Vdc, V _{EB} = 0) TIP29AG, TIP30AG (V _{CE} = 80 Vdc, V _{EB} = 0) TIP29BG, TIP30BG (V _{CE} = 100 Vdc, V _{EB} = 0) TIP29CG, TIP30CG	I _{CES}	- - - -	200 200 200 200	μAdc
Emitter Cutoff Current (V _{BE} = 5.0 Vdc, I _C = 0)	I _{EBO}	-	1.0	mAdc
ON CHARACTERISTICS (Note 2)				
DC Current Gain (I _C = 0.2 Adc, V _{CE} = 4.0 Vdc) (I _C = 1.0 Adc, V _{CE} = 4.0 Vdc)	h _{FE}	40 15	- 75	-
Collector-Emitter Saturation Voltage (I _C = 1.0 Adc, I _B = 125 mAdc)	V _{CE(sat)}	-	0.7	Vdc
Base-Emitter On Voltage (I _C = 1.0 Adc, V _{CE} = 4.0 Vdc)	V _{BE(on)}	-	1.3	Vdc
DYNAMIC CHARACTERISTICS				
Current-Gain - Bandwidth Product (Note 3) (I _C = 200 mAdc, V _{CE} = 10 Vdc, f _{test} = 1.0 MHz)	f _T	3.0	-	MHz
Small-Signal Current Gain (I _C = 0.2 Adc, V _{CE} = 10 Vdc, f = 1.0 kHz)	h _{fe}	20	-	-

Product parametric performance is indicated in the Electrical Characteristics for the listed test conditions, unless otherwise noted. Product performance may not be indicated by the Electrical Characteristics if operated under different conditions.

2. Pulse Test: Pulse Width ≤ 300 μs, Duty Cycle ≤ 2.0%

3. f_T = |h_{fe}| • f_{test}

TIP29, A, B, C (NPN), TIP30, A, B, C (PNP)

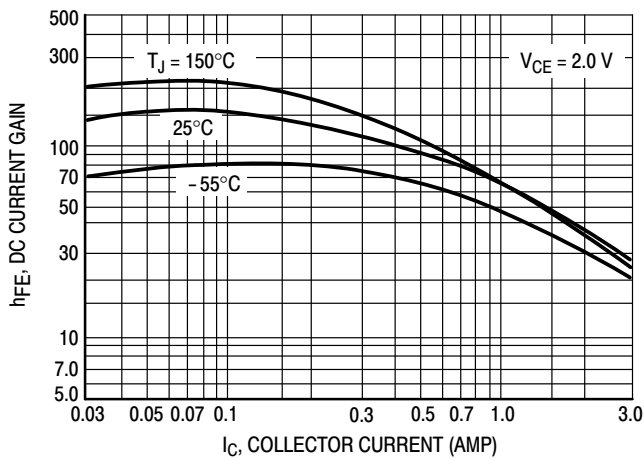

Figure 1. DC Current Gain

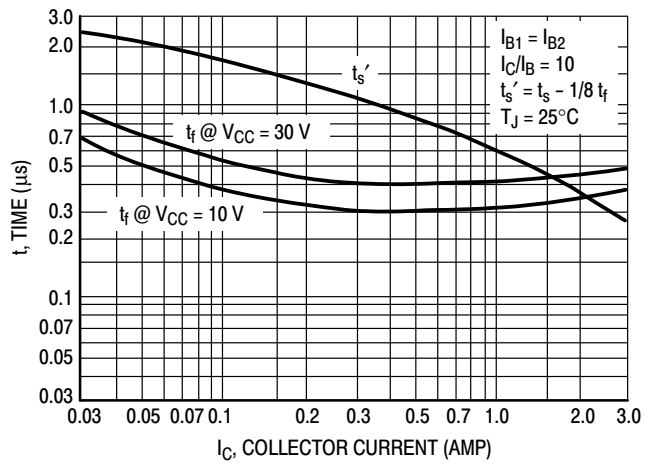

Figure 2. Turn-Off Time

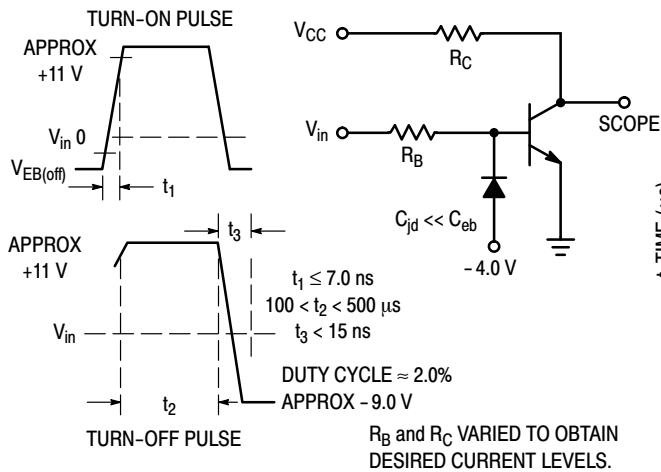

Figure 3. Switching Time Equivalent Circuit

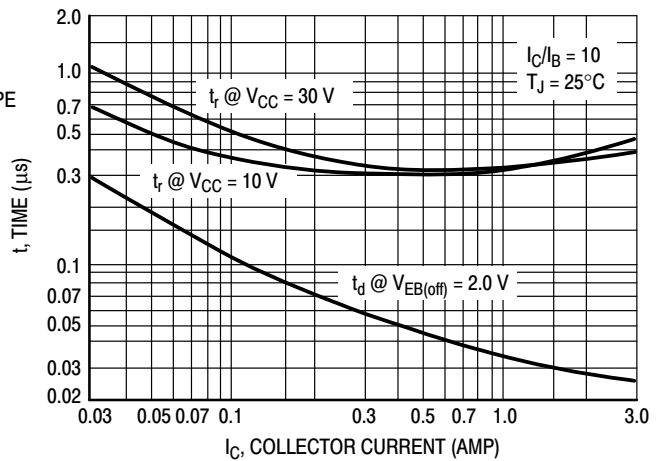

Figure 4. Turn-On Time

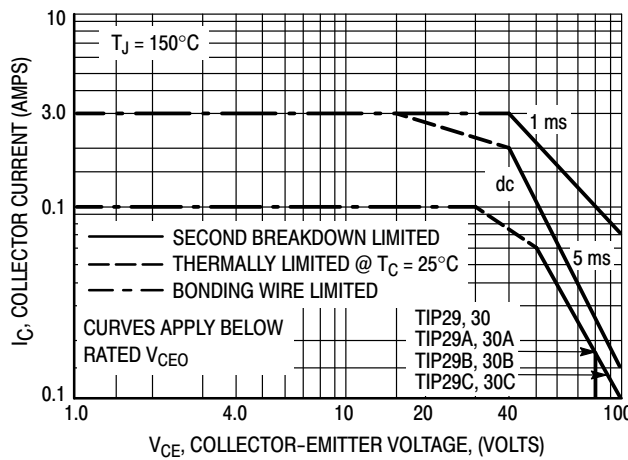

Figure 5. Active Region Safe Operating Area

There are two limitations on the power handling ability of a transistor: average junction temperature and second breakdown. Safe operating area curves indicate $I_C - V_{CE}$ operation; i.e., the transistor must not be subjected to greater dissipation than the curves indicate.

The data of Figure 5 is based on $T_{J(pk)} = 150^\circ\text{C}$; T_C is variable depending on conditions. Second breakdown pulse limits are valid for duty cycles to 10% provided $T_{J(pk)} \leq 150^\circ\text{C}$. At high case temperatures, thermal limitations will reduce the power that can be handled to values less than the limitations imposed by second breakdown.

TIP29, A, B, C (NPN), TIP30, A, B, C (PNP)

ORDERING INFORMATION

Device	Package	Shipping
TIP29G	TO-220 (Pb-Free)	50 Units / Rail
TIP29AG	TO-220 (Pb-Free)	50 Units / Rail
TIP29BG	TO-220 (Pb-Free)	50 Units / Rail
TIP29CG	TO-220 (Pb-Free)	50 Units / Rail
TIP30G	TO-220 (Pb-Free)	50 Units / Rail
TIP30AG	TO-220 (Pb-Free)	50 Units / Rail
TIP30BG	TO-220 (Pb-Free)	50 Units / Rail
TIP30CG	TO-220 (Pb-Free)	50 Units / Rail

TIP29, A, B, C (NPN), TIP30, A, B, C (PNP)

PACKAGE DIMENSIONS

TO-220 CASE 221A-09 ISSUE AH

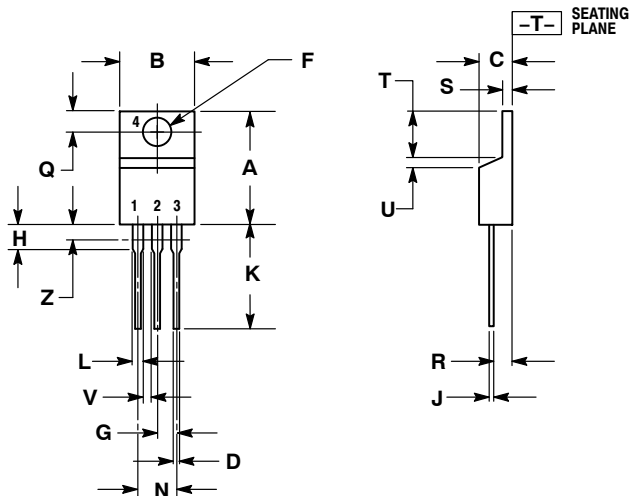

- NOTES:
1. DIMENSIONING AND TOLERANCING PER ANSI Y14.5M, 1982.
 2. CONTROLLING DIMENSION: INCH.
 3. DIMENSION Z DEFINES A ZONE WHERE ALL BODY AND LEAD IRREGULARITIES ARE ALLOWED.

DIM	INCHES		MILLIMETERS	
	MIN	MAX	MIN	MAX
A	0.570	0.620	14.48	15.75
B	0.380	0.415	9.66	10.53
C	0.160	0.190	4.07	4.83
D	0.025	0.038	0.64	0.96
F	0.142	0.161	3.61	4.09
G	0.095	0.105	2.42	2.66
H	0.110	0.161	2.80	4.10
J	0.014	0.024	0.36	0.61
K	0.500	0.562	12.70	14.27
L	0.045	0.060	1.15	1.52
N	0.190	0.210	4.83	5.33
Q	0.100	0.120	2.54	3.04
R	0.080	0.110	2.04	2.79
S	0.045	0.055	1.15	1.39
T	0.235	0.255	5.97	6.47
U	0.000	0.050	0.00	1.27
V	0.045	---	1.15	---
Z	---	0.080	---	2.04

STYLE 1:

- PIN 1. BASE
2. COLLECTOR
3. EMITTER
4. COLLECTOR

ON Semiconductor and the  are registered trademarks of Semiconductor Components Industries, LLC (SCILLC) or its subsidiaries in the United States and/or other countries. SCILLC owns the rights to a number of patents, trademarks, copyrights, trade secrets, and other intellectual property. A listing of SCILLC's product/patent coverage may be accessed at www.onsemi.com/site/pdf/Patent-Marking.pdf. SCILLC reserves the right to make changes without further notice to any products herein. SCILLC makes no warranty, representation or guarantee regarding the suitability of its products for any particular purpose, nor does SCILLC assume any liability arising out of the application or use of any product or circuit, and specifically disclaims any and all liability, including without limitation special, consequential or incidental damages. "Typical" parameters which may be provided in SCILLC data sheets and/or specifications can and do vary in different applications and actual performance may vary over time. All operating parameters, including "Typicals" must be validated for each customer application by customer's technical experts. SCILLC does not convey any license under its patent rights nor the rights of others. SCILLC products are not designed, intended, or authorized for use as components in systems intended for surgical implant into the body, or other applications intended to support or sustain life, or for any other application in which the failure of the SCILLC product could create a situation where personal injury or death may occur. Should Buyer purchase or use SCILLC products for any such unintended or unauthorized application, Buyer shall indemnify and hold SCILLC and its officers, employees, subsidiaries, affiliates, and distributors harmless against all claims, costs, damages, and expenses, and reasonable attorney fees arising out of, directly or indirectly, any claim of personal injury or death associated with such unintended or unauthorized use, even if such claim alleges that SCILLC was negligent regarding the design or manufacture of the part. SCILLC is an Equal Opportunity/Affirmative Action Employer. This literature is subject to all applicable copyright laws and is not for resale in any manner.

PUBLICATION ORDERING INFORMATION

LITERATURE FULFILLMENT:

Literature Distribution Center for ON Semiconductor
P.O. Box 5163, Denver, Colorado 80217 USA
Phone: 303-675-2175 or 800-344-3860 Toll Free USA/Canada
Fax: 303-675-2176 or 800-344-3867 Toll Free USA/Canada
Email: orderlit@onsemi.com

N. American Technical Support: 800-282-9855 Toll Free
USA/Canada
Europe, Middle East and Africa Technical Support:
Phone: 421 33 790 2910
Japan Customer Focus Center
Phone: 81-3-5817-1050

ON Semiconductor Website: www.onsemi.com
Order Literature: <http://www.onsemi.com/orderlit>

For additional information, please contact your local Sales Representative

Mouser Electronics

Authorized Distributor

Click to View Pricing, Inventory, Delivery & Lifecycle Information:

[ON Semiconductor:](#)

[TIP29AG](#) [TIP29BG](#) [TIP29CG](#) [TIP30CG](#)