

# Model 2460 High-Current Interactive SourceMeter® Instrument

## User's Manual

2460-900-01 Rev. C / August 2019



2460-900-01C

2460

High-Current SourceMeter<sup>®</sup> Instrument  
User's Manual

© 2019, Keithley Instruments, LLC

Cleveland, Ohio, U.S.A.

All rights reserved.

Any unauthorized reproduction, photocopy, or use of the information herein, in whole or in part, without the prior written approval of Keithley Instruments, LLC, is strictly prohibited.

These are the original instructions in English.

TSP®, TSP-Link®, and TSP-Net® are trademarks of Keithley Instruments, LLC. All Keithley Instruments product names are trademarks or registered trademarks of Keithley Instruments, LLC.

Other brand names are trademarks or registered trademarks of their respective holders.

The Lua 5.0 software and associated documentation files are copyright © 1994 - 2015, Lua.org, PUC-Rio. You can access terms of license for the Lua software and associated documentation at the Lua licensing site (<http://www.lua.org/license.html>).

Microsoft, Visual C++, Excel, and Windows are either registered trademarks or trademarks of Microsoft Corporation in the United States and/or other countries.

Document number: 2460-900-01 Rev. C / August 2019

The following safety precautions should be observed before using this product and any associated instrumentation. Although some instruments and accessories would normally be used with nonhazardous voltages, there are situations where hazardous conditions may be present.

This product is intended for use by personnel who recognize shock hazards and are familiar with the safety precautions required to avoid possible injury. Read and follow all installation, operation, and maintenance information carefully before using the product. Refer to the user documentation for complete product specifications.

If the product is used in a manner not specified, the protection provided by the product warranty may be impaired.

The types of product users are:

**Responsible body** is the individual or group responsible for the use and maintenance of equipment, for ensuring that the equipment is operated within its specifications and operating limits, and for ensuring that operators are adequately trained.

**Operators** use the product for its intended function. They must be trained in electrical safety procedures and proper use of the instrument. They must be protected from electric shock and contact with hazardous live circuits.

**Maintenance personnel** perform routine procedures on the product to keep it operating properly, for example, setting the line voltage or replacing consumable materials. Maintenance procedures are described in the user documentation. The procedures explicitly state if the operator may perform them. Otherwise, they should be performed only by service personnel.

**Service personnel** are trained to work on live circuits, perform safe installations, and repair products. Only properly trained service personnel may perform installation and service procedures.

Keithley products are designed for use with electrical signals that are measurement, control, and data I/O connections, with low transient overvoltages, and must not be directly connected to mains voltage or to voltage sources with high transient overvoltages. Measurement Category II (as referenced in IEC 60664) connections require protection for high transient overvoltages often associated with local AC mains connections. Certain Keithley measuring instruments may be connected to mains. These instruments will be marked as category II or higher.

Unless explicitly allowed in the specifications, operating manual, and instrument labels, do not connect any instrument to mains.

Exercise extreme caution when a shock hazard is present. Lethal voltage may be present on cable connector jacks or test fixtures. The American National Standards Institute (ANSI) states that a shock hazard exists when voltage levels greater than 30 V RMS, 42.4 V peak, or 60 VDC are present. A good safety practice is to expect that hazardous voltage is present in any unknown circuit before measuring.

Operators of this product must be protected from electric shock at all times. The responsible body must ensure that operators are prevented access and/or insulated from every connection point. In some cases, connections must be exposed to potential human contact. Product operators in these circumstances must be trained to protect themselves from the risk of electric shock. If the circuit is capable of operating at or above 1000 V, no conductive part of the circuit may be exposed.

Do not connect switching cards directly to unlimited power circuits. They are intended to be used with impedance-limited sources. NEVER connect switching cards directly to AC mains. When connecting sources to switching cards, install protective devices to limit fault current and voltage to the card.

Before operating an instrument, ensure that the line cord is connected to a properly-grounded power receptacle. Inspect the connecting cables, test leads, and jumpers for possible wear, cracks, or breaks before each use.

When installing equipment where access to the main power cord is restricted, such as rack mounting, a separate main input power disconnect device must be provided in close proximity to the equipment and within easy reach of the operator.

For maximum safety, do not touch the product, test cables, or any other instruments while power is applied to the circuit under test. ALWAYS remove power from the entire test system and discharge any capacitors before: connecting or disconnecting cables or jumpers, installing or removing switching cards, or making internal changes, such as installing or removing jumpers.

Do not touch any object that could provide a current path to the common side of the circuit under test or power line (earth) ground. Always make measurements with dry hands while standing on a dry, insulated surface capable of withstanding the voltage being measured.

For safety, instruments and accessories must be used in accordance with the operating instructions. If the instruments or accessories are used in a manner not specified in the operating instructions, the protection provided by the equipment may be impaired.

Do not exceed the maximum signal levels of the instruments and accessories. Maximum signal levels are defined in the specifications and operating information and shown on the instrument panels, test fixture panels, and switching cards.

When fuses are used in a product, replace with the same type and rating for continued protection against fire hazard.

Chassis connections must only be used as shield connections for measuring circuits, NOT as protective earth (safety ground) connections.

If you are using a test fixture, keep the lid closed while power is applied to the device under test. Safe operation requires the use of a lid interlock.

If a  screw is present, connect it to protective earth (safety ground) using the wire recommended in the user documentation.

The  symbol on an instrument means caution, risk of hazard. The user must refer to the operating instructions located in the user documentation in all cases where the symbol is marked on the instrument.

The  symbol on an instrument means warning, risk of electric shock. Use standard safety precautions to avoid personal contact with these voltages.

The  symbol on an instrument shows that the surface may be hot. Avoid personal contact to prevent burns.

The  symbol indicates a connection terminal to the equipment frame.

If this  symbol is on a product, it indicates that mercury is present in the display lamp. Please note that the lamp must be properly disposed of according to federal, state, and local laws.

The **WARNING** heading in the user documentation explains hazards that might result in personal injury or death. Always read the associated information very carefully before performing the indicated procedure.

The **CAUTION** heading in the user documentation explains hazards that could damage the instrument. Such damage may invalidate the warranty.

The **CAUTION** heading with the  symbol in the user documentation explains hazards that could result in moderate or minor injury or damage the instrument. Always read the associated information very carefully before performing the indicated procedure. Damage to the instrument may invalidate the warranty.

Instrumentation and accessories shall not be connected to humans.

Before performing any maintenance, disconnect the line cord and all test cables.

To maintain protection from electric shock and fire, replacement components in mains circuits — including the power transformer, test leads, and input jacks — must be purchased from Keithley. Standard fuses with applicable national safety approvals may be used if the rating and type are the same. The detachable mains power cord provided with the instrument may only be replaced with a similarly rated power cord. Other components that are not safety-related may be purchased from other suppliers as long as they are equivalent to the original component (note that selected parts should be purchased only through Keithley to maintain accuracy and functionality of the product). If you are unsure about the applicability of a replacement component, call a Keithley office for information.

Unless otherwise noted in product-specific literature, Keithley instruments are designed to operate indoors only, in the following environment: Altitude at or below 2,000 m (6,562 ft); temperature 0 °C to 50 °C (32 °F to 122 °F); and pollution degree 1 or 2.

To clean an instrument, use a cloth dampened with deionized water or mild, water-based cleaner. Clean the exterior of the instrument only. Do not apply cleaner directly to the instrument or allow liquids to enter or spill on the instrument. Products that consist of a circuit board with no case or chassis (e.g., a data acquisition board for installation into a computer) should never require cleaning if handled according to instructions. If the board becomes contaminated and operation is affected, the board should be returned to the factory for proper cleaning/servicing.

Safety precaution revision as of June 2017.

# Table of contents

---

<b>Introduction</b> .....	<b>1-1</b>
Welcome .....	1-1
Introduction to this manual .....	1-1
Extended warranty .....	1-2
Contact information .....	1-2
Available documentation .....	1-2
Organization of manual sections .....	1-3
Applications .....	1-3
<b>Front-panel overview</b> .....	<b>2-1</b>
Front-panel overview .....	2-1
Power the instrument on or off .....	2-4
Turn the 2460 output on or off .....	2-5
Touchscreen display .....	2-6
Select items on the touchscreen .....	2-7
Scroll bars .....	2-7
Swipe screens .....	2-7
Menu overview .....	2-11
Store measurements on a USB flash drive .....	2-12
Save screen captures to a USB flash drive .....	2-12
<b>Using a remote interface</b> .....	<b>3-1</b>
Remote communications interfaces .....	3-1
Supported remote interfaces .....	3-1
GPIB communications .....	3-2
Install the GPIB driver software .....	3-2
Install the GPIB cards in your computer .....	3-2
Connect GPIB cables to your instrument .....	3-3
Set the GPIB address .....	3-4
LAN communications .....	3-5
Set up LAN communications on the instrument .....	3-6
Set up LAN communications on the computer .....	3-7
USB communications .....	3-8
Connect a computer to the 2460 using USB .....	3-9
Communicate with the instrument .....	3-9
Using the web interface .....	3-13
Connect to the instrument web interface .....	3-13
LAN troubleshooting suggestions .....	3-14
Web interface Home page .....	3-15
Identify the instrument .....	3-15
Review events in the event log .....	3-16
Determine the command set to use .....	3-16

<b>Making basic front-panel measurements .....</b>	<b>4-1</b>
Introduction .....	4-1
Equipment required for this application.....	4-2
Device connections .....	4-2
Make front-panel measurements .....	4-3
How to make front-panel measurements .....	4-3
<b>Measuring low-resistance devices.....</b>	<b>5-1</b>
Introduction .....	5-1
Equipment required.....	5-1
Set up remote communications .....	5-2
Device connections .....	5-2
Low-resistance measurements .....	5-5
Set up the measurement from the front panel.....	5-6
View the measurements on the front-panel GRAPH swipe screen .....	5-7
View the buffer statistics on the front panel.....	5-8
Set up the low-resistance application using SCPI commands.....	5-8
Set up the low-resistance application using TSP commands.....	5-10
<b>Rechargeable battery measurements .....</b>	<b>6-1</b>
Introduction .....	6-1
Equipment required.....	6-3
Device connections .....	6-4
Automated battery charge and discharge cycle testing .....	6-7
Set up remote communications.....	6-8
Set up the battery application using SCPI commands .....	6-8
Set up the battery application using TSP commands.....	6-10
Battery application test results .....	6-13
<b>Generate an I-V sweep on an LED.....</b>	<b>7-1</b>
Introduction .....	7-1
Equipment and software required .....	7-2
Set up remote communications .....	7-2
Device connections .....	7-3
Generate an I-V sweep using KickStart .....	7-5
Configure the 2460 to use the KickStart software .....	7-5
Launch KickStart and set up the test.....	7-6
Run the test and view the graph.....	7-8
View and save the test data in tabular form .....	7-9
<b>Measuring I-V characteristics of a solar panel.....</b>	<b>8-1</b>
Introduction .....	8-1

Equipment required .....	8-2
Set up remote communications .....	8-2
Device connections .....	8-3
Solar panel characterization .....	8-4
Set up the solar panel I-V sweep from the front panel .....	8-5
Set up the solar panel I-V sweep using SCPI commands .....	8-7
Set up the solar panel I-V sweep using TSP commands .....	8-8
<b>Generating a high-current pulse train .....</b>	<b>9-1</b>
Introduction .....	9-1
Equipment required .....	9-1
Set up remote communications .....	9-2
Device connections .....	9-2
High-speed, high-power pulses from a remote interface .....	9-4
Define the pulse test parameters .....	9-5
Set up the source and measure functions .....	9-6
Set up the trigger model using TSP commands .....	9-7
TSP commands to output a high-current pulse train .....	9-9
<b>Troubleshooting FAQs .....</b>	<b>10-1</b>
About this section .....	10-1
Where can I find updated drivers? .....	10-1
How do I upgrade the firmware? .....	10-2
Why can't the 2460 read my USB flash drive? .....	10-3
How do I change the command set? .....	10-3
Why am I getting a 5074 event code? .....	10-4
How do I save the present state of the instrument? .....	10-5
Why did my settings change? .....	10-5
What are the Quick Setup options? .....	10-6
<b>Next steps .....</b>	<b>11-1</b>
Additional 2460 information .....	11-1



---

## Introduction

### In this section:

Welcome .....	1-1
Introduction to this manual .....	1-1
Extended warranty .....	1-2
Contact information .....	1-2
Available documentation .....	1-2
Organization of manual sections .....	1-3
Applications.....	1-3

## Welcome

Thank you for choosing a Keithley Instruments product. The 2460 High-Current SourceMeter® Instrument is a precise, low-noise instrument that combines a stable DC power supply, high-current source, electronic load, and a high-impedance multimeter. The design of this instrument features intuitive setup and control, enhanced signal quality and range, and better resistivity and resistance capabilities than similar products on the market.

The 2460 can source up to 7 A, and features 1 A, 4 A, 5 A, and 7 A ranges. With 0.012 percent basic accuracy at 6½-digit resolution, the 2460 is a good solution for testing a wide variety of materials and devices in applications such as power semiconductors, solar energy, high brightness LEDs, power conversion, electrochemistry, batteries, and more.

## Introduction to this manual

This manual provides detailed applications to help you achieve success with your Keithley Instruments 2460. It also provides information about the basics of the front panel to familiarize you with the instrument.

Each application includes an overview, followed by instructions to complete the application using the front panel, SCPI code, TSP® code, or Keithley KickStart Software.

More information about the commands that are used in these applications is available. Refer to the SCPI and TSP command reference sections of the *Model 2460 Reference Manual*. This manual is available at [tek.com/keithley](http://tek.com/keithley).

## Extended warranty

Additional years of warranty coverage are available on many products. These valuable contracts protect you from unbudgeted service expenses and provide additional years of protection at a fraction of the price of a repair. Extended warranties are available on new and existing products. Contact your local Keithley Instruments office, sales partner, or distributor for details.

## Contact information

If you have any questions after you review the information in this documentation, please contact your local Keithley Instruments office, sales partner, or distributor. You can also call the corporate headquarters of Keithley Instruments (toll-free inside the U.S. and Canada only) at 1-800-935-5595, or from outside the U.S. at +1-440-248-0400. For worldwide contact numbers, visit the [Keithley Instruments website \(tek.com/keithley\)](http://tek.com/keithley).

## Available documentation

The documentation for the 2460 High-Current SourceMeter® Instrument is available on the [Keithley Instruments website \(tek.com/keithley\)](http://tek.com/keithley).

The documentation includes:

- **Quick Start Guide:** Provides unpacking instructions, describes basic connections, reviews basic operation information, and provides a quick test procedure to ensure the instrument is operational.
- **User's Manual:** Provides application examples that you can use as a starting point to create your own applications.
- **Reference Manual:** Includes advanced operation topics, maintenance information, troubleshooting procedures, and in-depth descriptions of programming commands.
- **KickStart Software Quick Start Guide:** Provides instructions for the KickStart Software, which allows you to quickly make measurements and get results without having to program test scripts.
- **Accessories information:** Documentation for accessories that are available for the 2460.

For the latest drivers and additional support information, see the [Keithley Instruments website \(tek.com/keithley\)](http://tek.com/keithley).

## Organization of manual sections

This manual is organized into the following sections:

- [Front-panel overview](#) (on page 2-1): Describes the basics of using the front-panel interface.
- [Using a remote interface](#) (on page 3-1): Describes the basics of remote communications and using the instrument web interface.
- Application examples (see below): Provides detailed examples of how to use the 2460 in some typical situations.
- [Troubleshooting FAQs](#) (on page 10-1): Provides answers to frequently asked questions to help you troubleshoot common problems encountered with the 2460.
- [Next steps](#) (on page 11-1): Provides information about additional resources that can help you use the 2460.

The PDF version of this manual contains bookmarks for each section. The manual sections are also listed in the Table of Contents at the beginning of this manual.

For more information about bookmarks, see Adobe® Acrobat® or Reader® help.

## Applications

This manual provides application examples that show you how to perform tests from the front panel and over a remote interface. These applications are presented after the summary information about the 2460. The applications include:

- [Making basic front-panel measurements](#) (on page 4-1): Demonstrates the basic measurement functionality using a single 2460 and a two-terminal device under test (DUT).
- [Measuring low-resistance devices](#) (on page 5-1): Demonstrates how to use a 2460 to make low-resistance measurements of a 20 mΩ resistor.
- [Rechargeable battery measurements](#) (on page 6-1): Demonstrates how to use a single 2460 to perform automated battery discharge and charge cycle testing.
- [Generating an I-V sweep on an LED with KickStart](#) (on page 7-1): Demonstrates how use the 2460 to test high-brightness light-emitting diodes (LEDs) using Keithley KickStart Software.
- [Measuring I-V characteristics of a solar panel](#) (on page 8-1): Demonstrates using an I-V sweep to characterize a solar panel using the 2460.
- [Generating a high-current pulse train](#) (on page 9-1): Demonstrates how use a 2460 to generate a high-current pulse train using Test Script Processor (TSP®) commands and the 2460 trigger model.

## Front-panel overview

### In this section:









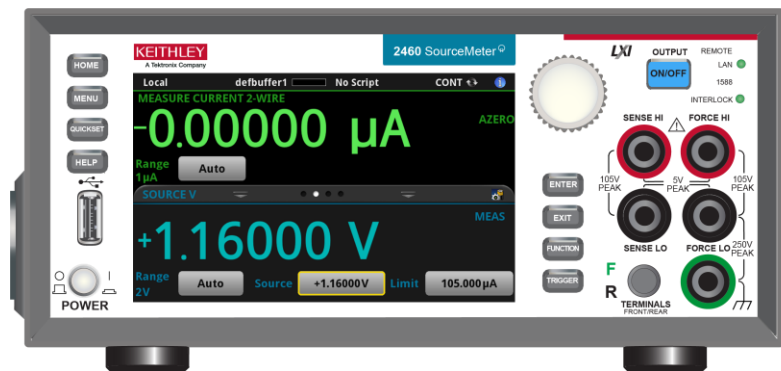



Front-panel overview.....	2-1
Power the instrument on or off .....	2-4
Turn the 2460 output on or off.....	2-5
Touchscreen display .....	2-6
Store measurements on a USB flash drive .....	2-12
Save screen captures to a USB flash drive .....	2-12



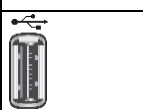



## Front-panel overview

The front panel of the 2460 is shown below. Descriptions of the controls on the front panel follow the figure.

Figure 1: 2460 front panel

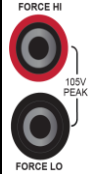

Control	Graphic	Description
POWER switch		Turns the instrument on or off. To turn the instrument on, press the power switch so that it is in the on position (I). To turn it off, press the power switch so that it is in the off position (O).
HOME key		Returns the display to the home screen.
MENU key		Opens the main menu. Press the icons on the main menu to open source, measure, views, trigger, scripts, and system screens.
QUICKSET key		Opens a menu of preconfigured setups, including voltmeter, ammeter, ohmmeter, and power supply. Also allows you to choose source and measure functions and adjust performance for better resolution or speed.
HELP key		Opens help for the area or item that is selected on the display. If there is no selection when you press the <b>HELP</b> key, it displays overview information for the screen you are viewing. To display help, hold the on-screen button while pressing the <b>HELP</b> key.
USB port		Saves reading buffer data and screen snapshots to a USB flash drive. You can also store and retrieve scripts to and from a USB flash drive. The flash drive must be formatted as a FAT or FAT32 drive.
Touchscreen		The 2460 has a high-resolution, five-inch color touchscreen display. The touchscreen accesses swipe screens and menu options. You can access additional screens by pressing the front-panel <b>MENU</b> , <b>QUICKSET</b> , and <b>FUNCTION</b> keys.
Navigation control		<b>Turning the navigation control:</b> Moves the cursor to highlight a list value or menu item so that you can select it. Turning the control when the cursor is in a value entry field increases or decreases the value in the field. <b>Pressing the navigation control:</b> Selects the highlighted choice or allows you to edit the selected field.
ENTER key		Selects the highlighted choice or allows you to edit the selected field.
EXIT key		Returns to the previous screen or closes a dialog box. For example, press the <b>EXIT</b> key when the main menu is displayed to return to the home screen. When you are viewing a subscreen (for example, the Event Log screen), press the <b>EXIT</b> key to return to the main menu screen.
FUNCTION key		Displays instrument functions. To select a function, touch the function name on the screen.
TRIGGER key		Accesses trigger-related settings and operations. The action of the <b>TRIGGER</b> key depends on the instrument state.
OUTPUT ON/OFF switch		Turns the output source on or off. The switch illuminates when the source output is on.

Control	Graphic	Description
REMOTE LED indicator	REMOTE 	Illuminates when the instrument is controlled through a remote interface.
LAN LED indicator	LAN 	Illuminates when the instrument is connected to a local area network (LAN).
1588 LED indicator	1588 	Note that 1588 functionality is not supported at this time.
INTERLOCK LED indicator	INTERLOCK 	Illuminates when the interlock is enabled.
SENSE terminals		Use the SENSE HI and SENSE LO terminal connections to measure voltage at the device under test (DUT). When you use sense leads, measurement of the voltage drop across the force leads is eliminated. This produces more accurate voltage sourcing and measurement at the DUT.
FORCE terminals		Use FORCE HI and FORCE LO terminal connections to source or sink voltage or current to or from a device under test (DUT).
FRONT/REAR TERMINALS switch		Activates the terminals on the front or rear panel. When the front-panel terminals are active, a green "F" is visible to the left of the FRONT/REAR switch. When the rear-panel terminals are active, a yellow "R" is visible to the left of the switch.
Chassis connection		Banana jack connector that provides a chassis connection.

## Power the instrument on or off

Follow the steps below to connect the 2460 to line power and turn on the instrument. The 2460 operates from a line voltage of 100 V to 240 V at a frequency of 50 Hz or 60 Hz. It automatically senses line voltage and frequency. Make sure the operating voltage in your area is compatible.

You must turn on the 2460 and allow it to warm up for at least one hour to achieve rated accuracies.

---

### CAUTION

Operating the instrument on an incorrect line voltage may cause damage to the instrument, possibly voiding the warranty.

---

---

### WARNING

The power cord supplied with the 2460 contains a separate protective earth (safety ground) wire for use with grounded outlets. When proper connections are made, the instrument chassis is connected to power-line ground through the ground wire in the power cord. In addition, a redundant protective earth connection is provided through a screw on the rear panel. This terminal should be connected to a known protective earth. In the event of a failure, not using a properly grounded protective earth and grounded outlet may result in personal injury or death due to electric shock.

Do not replace detachable mains supply cords with inadequately rated cords. Failure to use properly rated cords may result in personal injury or death due to electric shock.

---

**To connect the power cord:**

1. Make sure that the front-panel POWER switch is in the off (O) position.
2. Connect the female end of the supplied power cord to the AC receptacle on the rear panel.
3. Connect the male end of the power cord to a grounded AC outlet.

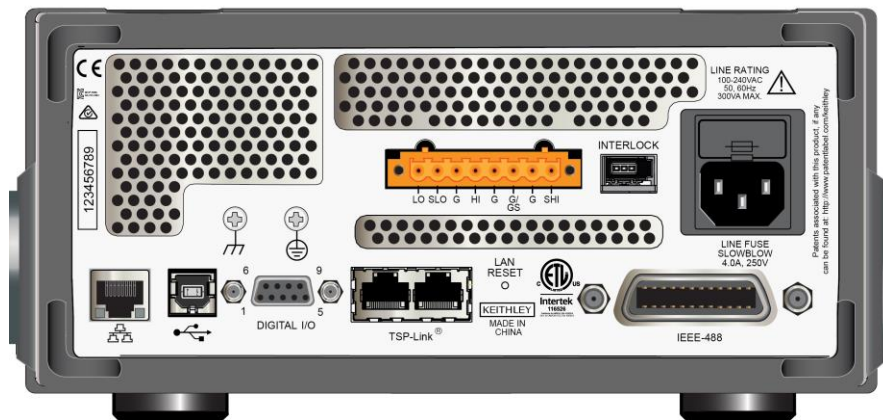
**Figure 2: 2460 rear panel****To turn a 2460 on or off:**

1. Before turning the instrument on, disconnect any devices under test (DUTs) from the 2460.
2. To turn your instrument on, press the front-panel **POWER** switch to place it in the on (I) position. The instrument displays a status bar as it powers on. The home screen is displayed when power on is complete.
3. To turn your instrument off, press the front-panel **POWER** switch to place it in the off (O) position.

## Turn the 2460 output on or off

You can turn the 2460 output on from the front panel or by sending remote commands.

---

### **⚠ WARNING**

Turning the 2460 output off does not place the instrument in a safe state (an interlock is provided for this function).

Hazardous voltages may be present on all output and guard terminals. To prevent electrical shock that could cause injury or death, never make or break connections to the 2460 while the instrument is powered on. Turn off the equipment from the front panel or disconnect the main power cord from the rear of the 2460 before handling cables. Putting the equipment into an output-off state does not guarantee that the outputs are powered off if a hardware or software fault occurs.

---



When the source of the instrument is turned off, it may not completely isolate the instrument from the external circuit. You can use the Output Off setting to place the 2460 in a known, noninteractive state during idle periods, such as when you are changing the device under test. The output-off states that can be selected for a 2460 are normal, high-impedance, zero, or guard.

See “Output-off state” in the *Model 2460 Reference Manual* for additional details.

#### **Using the front panel:**

Press the **OUTPUT ON/OFF** switch. The instrument is in the output-on state when the switch is illuminated. The instrument is in the output-off state when the switch is not illuminated.

#### **Using SCPI commands:**

To turn the output on, send the command:

```
:OUTPut:STATe ON
```

To turn the output off, send the command:

```
:OUTPut:STATe OFF
```

#### **Using TSP commands:**

To turn the output on, send the command:

```
smu.source.output = smu.ON
```

To turn the output off, send the command:

```
smu.source.output = smu.OFF
```

## Touchscreen display

The touchscreen display gives you quick front-panel access to source and measure settings, system configuration, instrument and test status, reading buffer information, and other instrument functionality. The display has multiple swipe screens that you can access by swiping the front panel. You can access additional interactive screens by pressing the front-panel MENU, QUICKSET, and FUNCTION keys.

---

### **CAUTION**

**Do not use sharp metal objects, such as tweezers or screwdrivers, or pointed objects, such as pens or pencils, to touch the touchscreen. It is strongly recommended that you use only fingers to operate the instrument. Use of clean-room gloves to operate the touchscreen is supported.**

---

## Select items on the touchscreen

To select an item on the displayed screen, do one of the following:

- Touch it with your finger
- Turn the navigation control to highlight the item, and then press the navigation control to select it

The following topics describe the 2460 touchscreen in more detail.

## Scroll bars

Some of the interactive screens have additional options that are only visible when you scroll down the screen. A scroll indicator on the right side of the touchscreen identifies these screens. Swipe the screen up or down to view the additional options.

The figure below shows a screen with a scroll bar.

Figure 3: Scroll bar

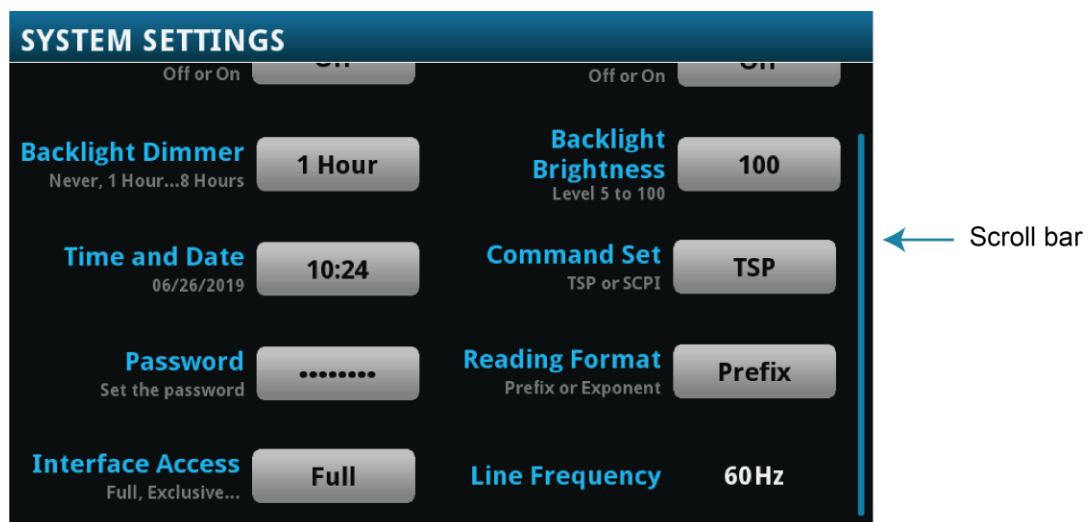

## Swipe screens





The 2460 touchscreen display has multiple screens that you can access by swiping left or right on the lower half of the display. The options available in the swipe screens are described in the following topics.

## Swipe screen heading bar

The heading bar of the swipe screen contains the following options.

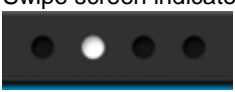
Figure 4: Swipe screens, maximized and minimized



#	Screen element	Description
1	Minimize indicator 	You can swipe down to minimize the swipe screens.
2	Swipe screen indicator 	Each circle represents one swipe screen. As you swipe right or left, a different circle changes color, indicating where you are in the screen sequence. Select a circle to move the swipe screen without swiping.
3	Calculations shortcut 	Select to open the CALCULATION SETTINGS menu.
4	Measure Settings shortcut 	Select to open the MEASURE SETTINGS menu for the selected function.
5	Restore indicator 	Indicates that you can swipe up to display the swipe screen.
6	Graph shortcut 	Select to open the Graph screen.

## SOURCE swipe screen

The SOURCE swipe screen shows the present value of the source and the set values for source, source range, and source limit. You can change the set values from the front panel by selecting the buttons on this screen.

Figure 5: SOURCE swipe screen



Source function indicators on the right side of the screen signify settings that affect the displayed source value:

- **MEAS:** Source readback is on and the value shown is the measured value of the source.
- **PROG:** Source readback is off and the value shown is the programmed source value. If the output is off, the displayed source value is replaced with **Output Off**.

When Limit label is shown in yellow, the instrument is limiting the source.

The present value is updated continuously when the measurement method is set to Continuous. When the measurement method is set to Manual Trigger Mode or Initiate Trigger Model, the value is updated when the next measurement occurs.

The icon on the right side of the swipe screen heading bar is a shortcut to the full SOURCE SETTINGS menu.

## SETTINGS swipe screen

The SETTINGS swipe screen gives you front-panel access to some instrument settings. It shows you the present settings and allows you to change, enable, or disable them quickly.

Figure 6: SETTINGS swipe screen

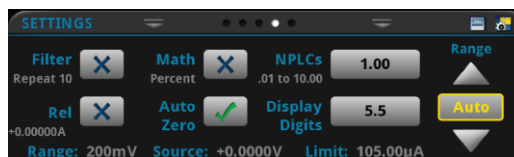

To disable or enable a setting, select the box next to the setting so that it shows an X (disabled) or a check mark (enabled).

The icons on the right side of the swipe screen heading bar are shortcuts to the CALCULATIONS SETTINGS and MEASURE SETTINGS menus.

For descriptions of the settings, use the navigation control to select the button, then press the HELP key.

## STATISTICS swipe screen

The STATISTICS swipe screen contains information about the readings in the active reading buffer. When the reading buffer is configured to fill continuously and overwrite old data with new data, the buffer statistics include the data that was overwritten. To get statistics that do not include data that has been overwritten, define a large buffer size that will accommodate the number of readings you will make. You can use the **Clear Active Buffer** button on this screen to clear the data from the active reading buffer.

Figure 7: 2460 STATISTICS swipe screen



## USER swipe screen

If you program custom text, it is displayed on the USER swipe screen. For example, you can program the 2460 to show that a test is in process. This swipe screen is only displayed if custom text has been defined. Refer to “Customizing a message for the USER swipe screen” in the *Model 2460 Reference Manual*.

Figure 8: USER swipe screen

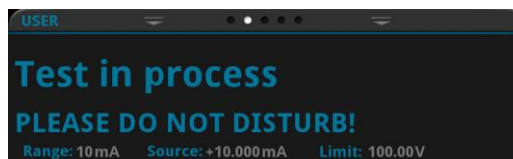

## GRAPH swipe screen

The GRAPH swipe screen shows a graphical representation of the readings in the presently selected reading buffer.

Figure 9: GRAPH swipe screen



To view the graph on the full screen and to access graph settings, select the graph icon on the right side of the swipe screen header. You can also open the full-function Graph screen by pressing the **MENU** key and selecting **Graph** under Views.

For more information about graphing measurements, see “Graphing” in the *Model 2460 Reference Manual*.

## Menu overview

To access the main menu, press the MENU key on the 2460 front panel. The figure below shows the organization of the main menu.

Figure 10: 2460 main menu



The main menu includes submenus that are labeled in green across the top of the display. Selecting an option in a submenu opens an interactive screen.

## Store measurements on a USB flash drive

If there is measurement data in the buffer, you can copy it from the 2460 to a USB flash drive. The information is saved in the CSV file format.

### *To store measurement data:*

1. Insert a flash drive into the front-panel USB port.
2. Press the **MENU** key.
3. In the Measure column, select **Reading Buffers**.
4. Select the buffer that you want to save.
5. Select **Save to USB**.
6. On the File Content dialog box, make selections as needed for your data set. You can press **HELP** to get information about each option.
7. Select **OK**.

## Save screen captures to a USB flash drive

You can save a screen capture of the front-panel display to a graphic file on a USB flash drive. The instrument saves the graphic file in PNG file format.

### *To save a screen capture:*

1. Insert a USB flash drive into the USB port on the front panel of the instrument.
2. Navigate to the screen you want to capture.
3. Press the **HOME** and **ENTER** keys. The instrument displays *Saving screen capture*.
4. Release the keys.

---

## Using a remote interface

### In this section:

Remote communications interfaces .....	3-1
Supported remote interfaces .....	3-1
GPIB communications.....	3-2
LAN communications .....	3-5
USB communications .....	3-8
Using the web interface.....	3-13
Determine the command set to use .....	3-16

## Remote communications interfaces

You can choose from one of several communication interfaces to send commands to and receive responses from the 2460.

You can control the 2460 from only one communications interface at a time. The first interface on which the instrument receives a message takes control of the instrument. If another interface sends a message, that interface can take control of the instrument. You may need to enter a password to change the interface, depending on the setting of interface access.

The 2460 automatically detects the type of communications interface (LAN, USB, or GPIB) when you connect to the respective port on the rear panel of the instrument. In most cases, you do not need to configure anything on the instrument. In addition, you do not need to reboot if you change the type of interface that is connected.

## Supported remote interfaces

The 2460 supports the following remote interfaces:

- **GPIB:** IEEE-488 instrumentation general-purpose interface bus
- **Ethernet:** Local-area-network communications
- **USB:** Type B USB port
- **TSP-Link:** A high-speed trigger synchronization and communications bus that test system builders can use to connect multiple instruments in a master-and-subordinate configuration

For details about TSP-Link, see “TSP-Link System Expansion Interface” in the *Model 2460 Reference Manual*.



## **GPIB communications**

The 2460 GPIB interface is IEEE Std 488.1 compliant and supports IEEE Std 488.2 common commands and status model topology.

You can have up to 15 devices connected to a GPIB interface, including the controller. The maximum cable length is the lesser of either:

- The number of devices multiplied by 2 m (6.5 ft)
- 20 m (65.6 ft)

You may see erratic bus operation if you ignore these limits.

## **Install the GPIB driver software**

Check the documentation for your GPIB controller for information about where to acquire drivers. Keithley Instruments also recommends that you check the website of the GPIB controller for the latest version of drivers or software.

It is important that you install the drivers before you connect the hardware. This prevents associating the incorrect driver to the hardware.

## **Install the GPIB cards in your computer**

Refer to the documentation from the GPIB controller vendor for information about installing the GPIB controllers.

## Connect GPIB cables to your instrument

To connect a 2460 to the GPIB interface, use a cable equipped with standard GPIB connectors, as shown below.

Figure 11: GPIB connector

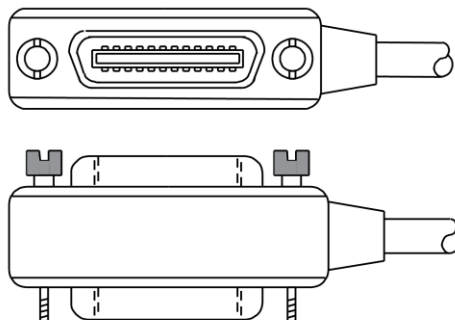

To allow many parallel connections to one instrument, stack the connectors. Each connector has two screws on it to ensure that connections remain secure. The figure below shows a typical connection diagram for a test system with multiple instruments.

---

### CAUTION

**To avoid possible mechanical damage, stack no more than three connectors on any one instrument. To minimize interference caused by electromagnetic radiation, use only shielded GPIB cables. Contact Keithley Instruments for shielded cables.**

---

Figure 12: Model 2460 IEEE-488 connections

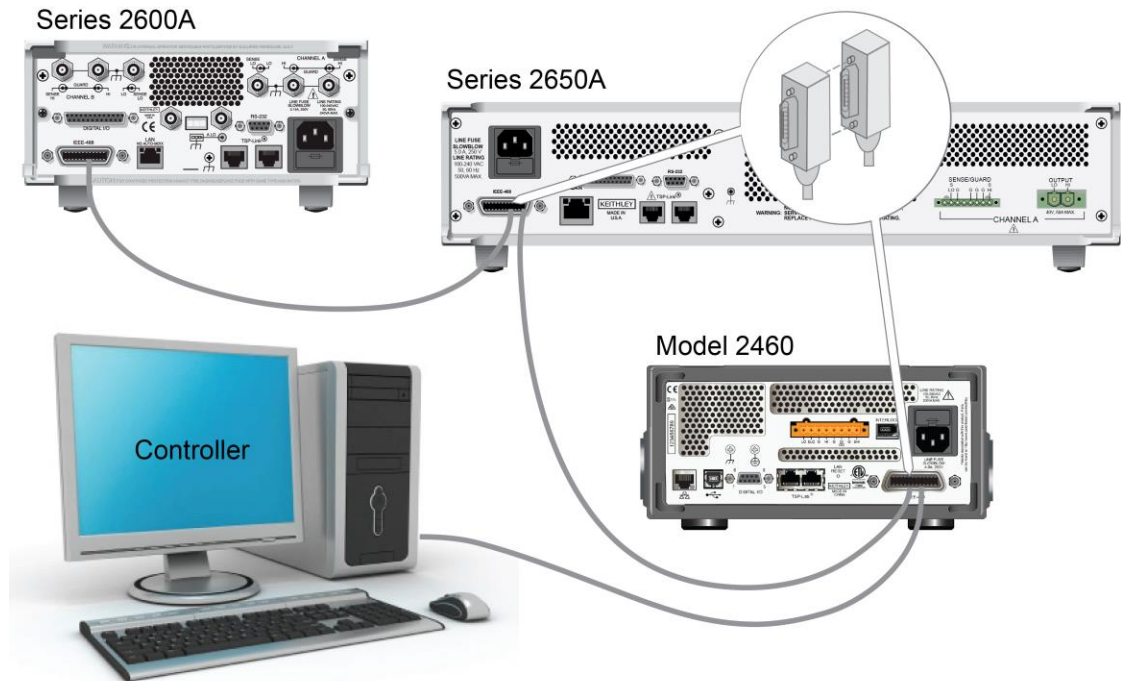

## Set the GPIB address

The default GPIB address is 18. You can set the address from 1 to 30 if it is unique in the system. This address cannot conflict with an address that is assigned to another instrument or to the GPIB controller.

---

### NOTE

GPIB controllers are usually set to 0 or 21. To be safe, do not configure any instrument to have an address of 21.

---

The instrument saves the address in nonvolatile memory. It does not change when you send a reset command or when you turn the power off and on again.

**To set the GPIB address from the front panel:**

1. Press the **MENU** key.
2. Select **Communication**.
3. Select the **GPIB** tab.
4. Set the GPIB **Address**.
5. Select **OK**.

---

## NOTE

You can also set the GPIB address using remote commands. Set the GPIB address with the SCPI command `:SYSTem:GPIB:ADDRess` or the TSP command `gpib.address`.

---

## LAN communications

You can communicate with the instrument using a local area network (LAN).

When you connect using a LAN, you can use a web browser to access the internal web page of the instrument and change some of the instrument settings. For more information, see [Using the web interface](#) (on page 3-13).

The 2460 is a version 1.5 LXI Device Specification 2016 instrument that supports TCP/IP and complies with IEEE Std 802.3 (ethernet LAN). There is one LAN port on the rear panel of the instrument that supports full connectivity on a 10 Mbps or 100 Mbps network. The 2460 automatically detects the speed.

The 2460 also supports Multicast DNS (mDNS) and DNS Service Discovery (DNS-SD), which are useful on a LAN with no central administration.

---

## NOTE

Contact your network administrator to confirm your specific network requirements before setting up a LAN connection.

If you have problems setting up the LAN, refer to [LAN troubleshooting suggestions](#) (on page 3-14).

---

## Set up LAN communications on the instrument

This section describes how to set up manual or automatic LAN communications on the instrument.

---

### NOTE

If you are using a 2460 with no front panel, you can check the settings with the SCPI command `:SYSTEM:COMMunication:LAN:CONFigure` or the TSP command `lan.ipconfig()`.

---

## Set up automatic LAN configuration

If you are connecting to a LAN that has a DHCP server or if you have a direct connection between the instrument and a host computer, you can use automatic IP address selection.

If you select Auto, the instrument attempts to get an IP address from a DHCP server. If this fails, it reverts to an IP address in the range of 169.254.1.0 through 169.254.254.255.

---

### NOTE

Both the host computer and the instrument should be set to use automatic LAN configuration. Though it is possible to have one set to manual configuration, it is more complicated to set up.

---

#### *To set up automatic IP address selection using the front panel:*

1. Press the **MENU** key.
2. Under System, select **Communication**.
3. Select the **LAN** tab.
4. For TCP/IP Mode, select **Auto**.
5. Select **Apply Settings** to save your settings.

## Set up manual LAN configuration

If necessary, you can set the IP address on the instrument manually.

You can also enable or disable the DNS settings and assign a host name to the DNS server.

---

### NOTE

Contact your corporate information technology (IT) department to secure a valid IP address for the instrument when placing the instrument on a corporate network.

The instrument IP address has leading zeros, but the computer IP address cannot.

---

**To set up manual IP address selection on the instrument:**

1. Press the **MENU** key.
2. Under System, select **Communication**.
3. Select the **LAN** tab.
4. For TCP/IP Mode, select **Manual**.
5. Enter the **IP Address**.
6. Enter the **Gateway** address.
7. Enter the **Subnet** mask.
8. Select **Apply Settings** to save your settings.

## Set up LAN communications on the computer

This section describes how to set up the LAN communications on your computer.

---

### NOTE

Do not change your IP address without consulting your system administrator. If you enter an incorrect IP address, it can prevent your computer from connecting to your corporate network or it may cause interference with another networked computer.

Record all network configurations before modifying any existing network configuration information on the network interface card. Once the network configuration settings are updated, the previous information is lost. This may cause a problem reconnecting the host computer to a corporate network, particularly if DHCP is disabled.

Be sure to return all settings to their original configuration before reconnecting the host computer to a corporate network. Contact your system administrator for more information.

---

## Verify the LAN connection on the 2460

Make sure that your 2460 is connected to the network by confirming that your instrument was assigned an IP address.

### *To verify the LAN connection:*

1. Press the **MENU** key.
2. Under System, select **Communication**.
3. Select the **LAN** tab.

A green LAN status indicator on the lower left of the LAN tab confirms that your instrument was assigned an IP address.

In addition, the green LAN LED on the upper right of the front panel is on when your instrument is connected to the network.

## Use the LXI Discovery Tool

To find the IP address of the 2460, use the LXI Discovery Tool, a utility that is available from the Resources tab of the [LXI Consortium website \(Ixistandard.org\)](http://ixistandard.org).

## USB communications

To use the rear-panel USB port, you must have the Virtual Instrument Software Architecture (VISA) layer on the host computer. See “How to install the Keithley I/O Layer” in the *Model 2460 Reference Manual* for more information.

VISA contains a USB-class driver for the USB Test and Measurement Class (USBTMC) protocol that, once installed, allows the Microsoft® Windows® operating system to recognize the instrument.

When you connect a USB device that implements the USBTMC or USBTMC-USB488 protocol to the computer, the VISA driver automatically detects the device. Note that the VISA driver only automatically recognizes USBTMC and USBTMC-USB488 devices. It does not recognize other USB devices, such as printers, scanners, and storage devices.

In this section, “USB instruments” refers to devices that implement the USBTMC or USBTMC-USB488 protocol.

## Connect a computer to the 2460 using USB

To communicate from a computer to the instrument, you need a USB cable with a USB Type B connector end and a USB Type A connector end. You need a separate USB cable for each instrument you plan to connect to the computer at the same time using the USB interface.

### *To connect an instrument to a computer using USB:*

1. Connect the Type A end of the cable to the computer.
2. Connect the Type B end of the cable to the instrument.
3. Turn on the instrument power. When the computer detects the new USB connection, the Found New Hardware Wizard starts.
4. If the “Can Windows connect to Windows Update to search for software?” dialog box opens, select **No**, and then select **Next**.
5. On the “USB Test and Measurement device” dialog box, select **Next**, and then select **Finish**.

## Communicate with the instrument

For the instrument to communicate with the USB device, you must use NI-VISA™. VISA requires a resource string in the following format to connect to the correct USB instrument:

```
USB0::0x05e6::0x2460::[serial number]::INSTR
```

Where:

- 0x05e6: The Keithley vendor ID
- 0x2460: The instrument model number
- [serial number]: The serial number of the instrument (the serial number is also on the rear panel)
- INSTR: Use the USBTMC protocol

The resource string is displayed on the bottom right of the System Communications screen. Select **Menu**, then **Communication** to open the System Communications menu and select the **USB** tab.

You can also retrieve the resource string by running the Keithley Configuration Panel, which automatically detects all instruments connected to the computer.

If you installed the Keithley I/O Layer, you can access the Keithley Configuration Panel through the Microsoft® Windows® Start menu.



**To use the Keithley Configuration Panel to determine the VISA resource string:**

1. Select **Start > Keithley Instruments > Keithley Configuration Panel**. The Select Operation dialog box is displayed.

**Figure 13: Select Operation dialog box**

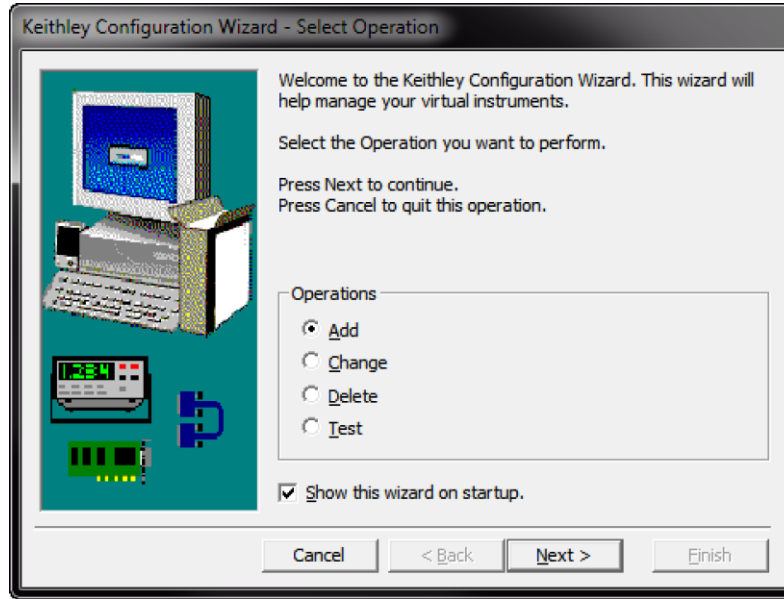

2. Select **Add**.
3. Select **Next**. The Select Communication Bus dialog box is displayed.

**Figure 14: Select Communication Bus dialog box**

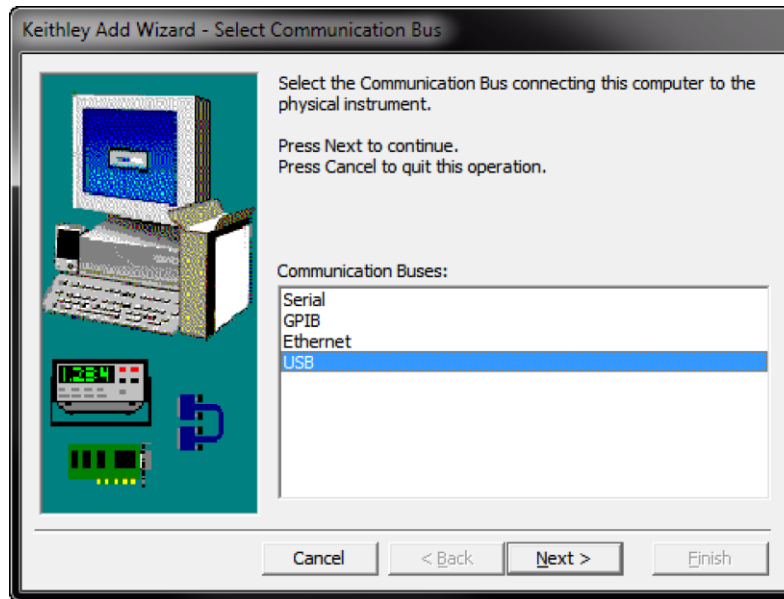

4. Select **USB**.
5. Select **Next**. The Select Instrument Driver dialog box is displayed.

**Figure 15: Select Instrument Driver dialog box**

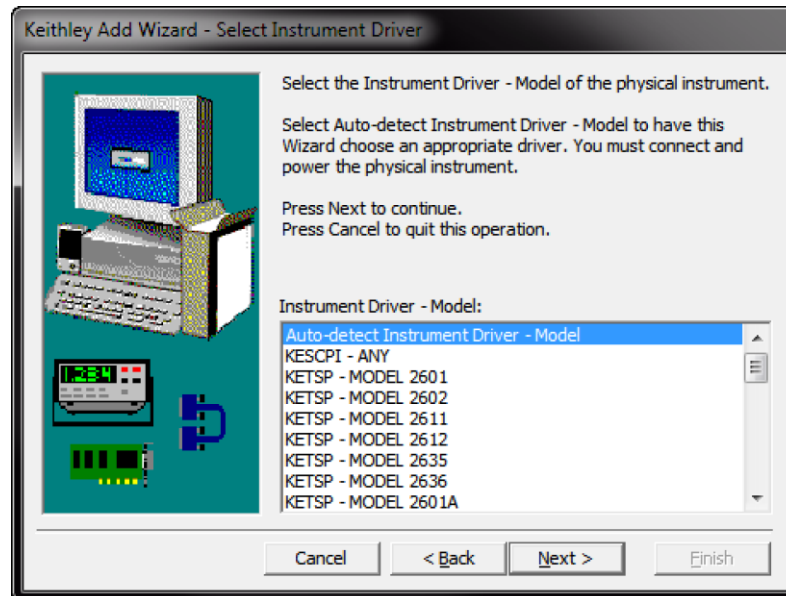

6. Select **Auto-detect Instrument Driver - Model**.
7. Select **Next**. The Configure USB Instrument dialog box is displayed with the detected instrument VISA resource string visible.
8. Select **Next**. The Name Virtual Instrument dialog box is displayed.

**Figure 16: Name Virtual Instrument dialog box**

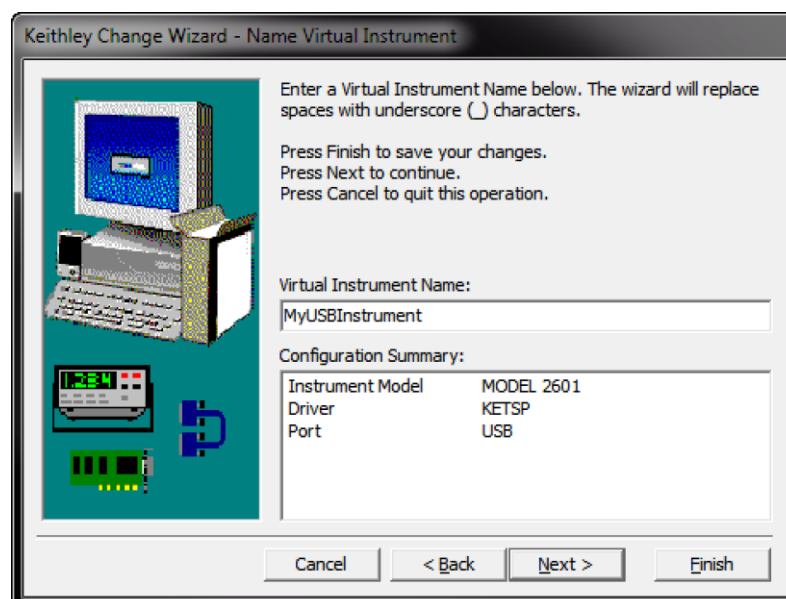

9. In the Virtual Instrument Name box, enter a name that you want to use to refer to the instrument.
10. Select **Finish**.
11. Select **Cancel** to close the Wizard.
12. Save the configuration. From the Keithley Configuration Panel, select **File > Save**.

**Verify the instrument through the Keithley Communicator:**

1. Set the instrument to use the SCPI command set. Refer to [How do I change the command set?](#) (on page 10-3) for instruction.
2. Select **Start > Keithley Instruments > Keithley Communicator**.
3. Select **File > Open Instrument** to open the instrument you just named.

**Figure 17: Keithley Communicator Open an Instrument**

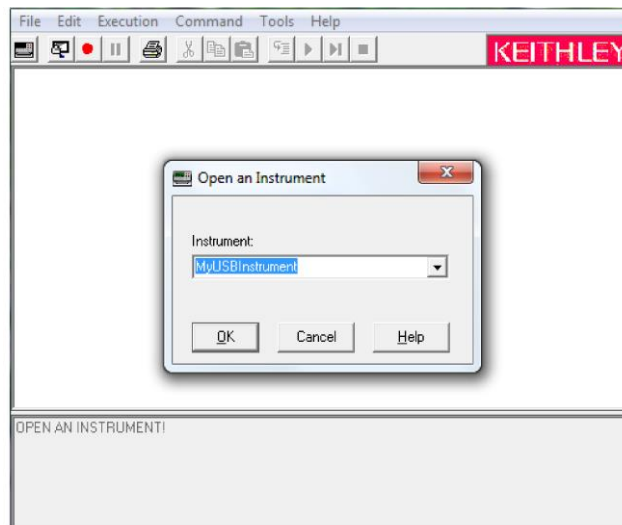

4. Select **OK**.
5. Send a command to the instrument and see if it responds.

---

## NOTE

If you have a full version of NI-VISA on your system, you can run NI-MAX or the VISA Interactive Control utility. See the National Instruments documentation for information.

---

## Using the web interface

The 2460 web interface allows you to make settings and control your instrument through a web page. The web page includes:

- Instrument status.
- The instrument model, serial number, firmware revision, and the last LXI message.
- An ID button to help you locate the instrument.
- A virtual front panel and command interface that you can use to control the instrument.
- Ability to download data from specific reading buffers into a CSV file.
- Administrative options and LXI information.

The instrument web page resides in the firmware of the instrument. Changes you make through the web interface are immediately made in the instrument.

## Connect to the instrument web interface

When the LAN and instrument establish a connection, you can open the web page for the instrument.

### ***To access the web interface:***

1. Open a web browser on the host computer.
2. Enter the IP address of the instrument in the address box of the web browser. For example, if the instrument IP address is 192.168.1.101, enter `192.168.1.101` in the browser address box.
3. Press **Enter** on the computer keyboard to open the instrument web page.
4. If prompted, enter a user name and password. The default is `admin` for both.

## LAN troubleshooting suggestions

If you are unable to connect to the web interface of the instrument, check the following items:

- The network cable is in the LAN port on the rear panel of the instrument, not one of the TSP-Link® ports.
- The network cable is in the correct port on the computer. The LAN port of a laptop may be disabled when the laptop is in a docking station.
- The setup procedure used the configuration information for the correct ethernet card.
- The network card of the computer is enabled.
- The IP address of the instrument is compatible with the IP address on the computer.
- The subnet mask address of the instrument is the same as the subnet mask address of the computer.

You can also try restarting the computer and the instrument.

### ***To restart the instrument:***

1. Turn the power to the instrument off, and then on.
2. Wait at least 60 seconds for the network configuration to be completed.

### ***To set up LAN communications:***

1. Press the **MENU** key.
2. Under System, select **Communication**.
3. Select the **LAN** tab.
4. Verify the settings.

If the above actions do not correct the problem, contact your system administrator.

## Web interface Home page

Figure 18: 2460 web interface Home page

The screenshot shows the web interface for a Keithley Model 2460 Source Measure Unit. The page has a red header with the Keithley logo and 'A Tektronix Company' text. Below the header is a navigation menu on the left with options: Home, Admin, LXI Home, IP Config, Log, Virtual Front Panel, Send Commands, Extract Data, and Help. The main content area is titled 'Model 2460 Source Measure Unit' and contains a table with the following information:

Instrument Model:	2460		
Manufacturer:	Keithley Instruments		
Serial Number:	81428274	Firmware Revision:	1.7.0
TCP Raw Socket:	5025	Telnet Port:	23
Last LXI Message: <a href="#">(history)</a>	Reading buffer defbuffer1 is 0% filled		

Below the table is a photograph of the physical Keithley Model 2460 instrument. The device's screen displays two measurements:  $+0.65650 \Omega$  and  $+6.99994 A$ . To the right of the screen are several control knobs and buttons. An 'ID' button is visible in the top right corner of the web page interface.

The Home page of the instrument provides information about the instrument. It includes:

- The instrument model number, manufacturer, serial number, and firmware revision number.
- The TCP Raw Socket number and Telnet Port number.
- The last LXI message. The history link opens the LXI Home page.
- The ID button, which allows you to identify the instrument. Refer to [Identify the instrument](#) (on page 3-15).

## Identify the instrument

If you have a bank of instruments, you can select the ID button to determine which one you are communicating with.

### *To identify the instrument:*

1. On the Home page, select the **ID** button. The button turns green and the LAN status indicator on the front panel of the instrument blinks. On instruments with a front-panel interface, the System Communications menu also opens and the LXI LAN indicator on the LAN tab blinks.
2. Select the **ID** button again to return the button to its original color and return the LAN status indicators to steady on.

## Review events in the event log

Under LXI Home, the Log option opens the event log. The event log records all LXI events that the instrument generates and receives. The log includes the following information:

- The EventID column, which shows the identifier of the event that generated the event message.
- The System Timestamp column, which displays the seconds and nanoseconds when the event occurred.
- The Data column, which displays the text of the event message.

To clear the event log and update the information on the screen, select the **Refresh** button.

## Determine the command set to use

You can control the 2460 with command sets that are based on the SCPI or Test Script Processor (TSP®) programming languages. You can change the command set that you use with the 2460. The remote command sets that are available include:

- **SCPI:** An instrument-specific language built on the SCPI standard.
- **TSP:** A scripting programming language that contains instrument-specific control commands that can be executed from a stand-alone instrument. You can use TSP to send individual commands or use it to combine commands into scripts.

If you change the command set, reboot the instrument.

You cannot combine the command sets.

---

### NOTE

As delivered from Keithley Instruments, the 2460 is set to work with the SCPI command set.

---

#### ***To set the command set from the front panel:***

1. Press the **MENU** key.
2. Under System, select **Settings**.
3. Select the appropriate **Command Set**.

You are prompted to confirm the change to the command set and reboot.

***To verify which command set is selected from a remote interface, send the command:***

```
*LANG?
```

***To change to the SCPI command set from a remote interface, send the command:***

```
*LANG SCPI
```

Reboot the instrument.

***To change to the TSP command set from a remote interface, send the command:***

```
*LANG TSP
```

Reboot the instrument.



---

## Making basic front-panel measurements

### In this section:

Introduction .....	4-1
Equipment required for this application .....	4-2
Device connections .....	4-2
Make front-panel measurements.....	4-3

## Introduction

You can use the 2460 to source voltage or current and make measurements from the front panel.

---

### NOTE

Make sure you select functions before you make changes to other instrument settings. The options that you have for settings depend on the functions that are active when you make the changes. If you make a change that is not compatible with the active functions, you may get unexpected results or you may receive an event message. Also note that when you select a different function, the instrument clears the buffer. The applications in this manual illustrate the order in which you should perform operations for best results.

---

In this application, you make measurements on a 10 k $\Omega$  resistor by sourcing voltage and measuring current. You can make similar measurements on any two-terminal device under test (DUT) if appropriate source values are used.

Some of the methods you can use to set up the 2460 to make measurements from the front panel include:

- **Use Quicksets.** Press the **QUICKSET** key to open a menu of preconfigured setups, including voltmeter, ammeter, ohmmeter, and power supply setups. It also allows you to choose test functions and adjust performance for better resolution or speed.
- **Select source and measure functions.** Press the **FUNCTION** key to select from a list of source and measure functions.
- **Use menu options.** Press the **MENU** key to open a menu of options.

After selecting your source and measure functions, select buttons on the 2460 home screen and Settings swipe screens to change the settings.

You will use a combination of these methods to set up the measurement for this application.

## Equipment required for this application

Equipment required for this application:

- 2460 High-Current SourceMeter® Instrument
- Two insulated banana cables; you can use the set that is provided with the 2460, the Keithley Instruments Model 8608 High-Performance Clip Lead Set
- One 10 kΩ resistor to test

## Device connections

### NOTE

Turn the power to the instrument off before attaching connections to the 2460.

Connect the 2460 to the resistor in a 2-wire (local sense) configuration. In this configuration, the device is connected between the FORCE HI and FORCE LO terminals.

The physical connections to the front panel are shown in the following figure.

**Figure 19: 2460 2-wire front-panel connections**



## Make front-panel measurements

For this application, you will:

- Select the source and measure functions
- Select the source range
- Set the source value
- Set the source limit
- Select the measurement range
- Turn on the source output
- Observe the readings on the display
- Turn off the source output

## How to make front-panel measurements

*To make a measurement from the front panel:*

1. Press the **POWER** switch on the front panel to turn on the instrument.
2. On the front panel, press the **FUNCTION** key.
3. Under Source Voltage and Measure, select **Current**.
4. Select the source range. On the home screen, under SOURCE V, select **Range**.
5. Select **20 V**.
6. Select **Source**.
7. Enter **10 V** and select **OK**.
8. Select **Limit**.
9. Enter **10 mA** and select **OK**.
10. In the MEASURE area of the home screen, select **Range**.
11. Select **Auto**.
12. Turn on the output by pressing the **OUTPUT ON/OFF** switch. The OUTPUT indicator light turns on.
13. Observe the readings on the display. For the 10 kΩ resistor, typical display values are:  
1.00000 mA  
+9.99700 V
14. When measurements are complete, turn the output off by pressing the **OUTPUT ON/OFF** switch. The OUTPUT indicator light turns off.

---

## Measuring low-resistance devices

### In this section:

Introduction.....	5-1
Equipment required .....	5-1
Set up remote communications .....	5-2
Device connections .....	5-2
Low-resistance measurements.....	5-5

## Introduction

This application example demonstrates how to use the 2460 to measure a low-resistance device.

You may need to make low-resistance measurements ( $<10\ \Omega$ ) in a number of applications. Typical applications include continuity testing of cables and connectors, substrate vias, and resistors.

Typically, you make these resistance measurements by forcing a current and measuring the resulting voltage drop. The 2460 automatically calculates the resistance. The measured voltage is usually in the mV range or less. Built-in features of the 2460 optimize low-resistance measurements, such as remote sensing and offset compensation.

## Equipment required

- One 2460 High-Current SourceMeter® Instrument
- For front-panel connections, use four insulated banana cables, such as the Keithley Instruments Model 8608 High-Performance Clip Lead Set (one set included with the 2460; you will need another set)
- For rear-panel connections, use one Model 2460-KIT Screw-Terminal Connector Kit (provided with the 2460), or you can use one set of Model 2460-BAN Banana Test Leads/Adapter Cables (with appropriate connections to the device)
- One low-resistance device to be tested; the application shown here uses a 20 m $\Omega$  resistor

## Set up remote communications

You can run this application from the front panel or any of the supported communication interfaces for the instrument (GPIB, USB, or ethernet).

The following figure shows the rear-panel connection locations for the remote communication interfaces. For additional information about setting up remote communications, see [Remote communications interfaces](#) (on page 3-1).

**Figure 20: 2460 remote interface connections**

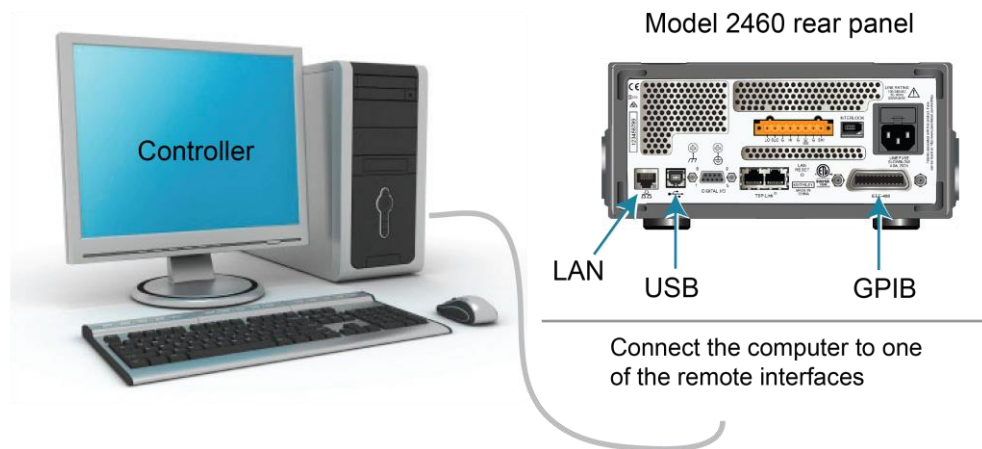

## Device connections

To provide the best measurement accuracy, use the four-wire (Kelvin) measurement method for this test. This method eliminates the effects of lead resistance on the measurement accuracy. It is the preferred method when measuring low resistances.

### ***To use the 4-wire connection method:***

- Connect one set of test leads to the FORCE LO and FORCE HI terminals; this setup forces a current through the device under test.
- Connect the other set of test leads to the SENSE HI and SENSE LO terminals, which measure the voltage drop across the device under test (DUT).

---

**⚠ WARNING**

Hazardous voltages may be present on all output and guard terminals. To prevent electrical shock that could cause injury or death, never make or break connections to the 2460 while the output is on.

To prevent electric shock, test connections must be configured such that the user cannot come in contact with conductors or any device under test (DUT) that is in contact with the conductors. It is good practice to disconnect power before connecting DUTs. Safe installation requires proper shields, barriers, and grounding to prevent contact with conductors.

There is no internal connection between protective earth (safety ground) and the LO terminals of the 2460. Therefore, hazardous voltages (more than  $30 V_{RMS}$ ) can appear on LO terminals. This can occur when the instrument is operating in any mode. To prevent hazardous voltage from appearing on the LO terminals, connect the LO terminal to protective earth (safety ground) if your application allows it. You can connect the LO terminal to the chassis ground terminal on the front panel or the chassis ground screw terminal on the rear panel. Note that the front-panel terminals are isolated from the rear-panel terminals. Therefore, if you are using the front-panel terminals, ground to the front-panel LO terminal. If using the rear-panel terminals, ground to the rear panel LO terminal. Failure to follow these guidelines can result in injury, death, or instrument damage.

---

The following figure shows the schematic for the application.

**Figure 21: Sourcing current and measuring resistance using a 4-wire configuration**

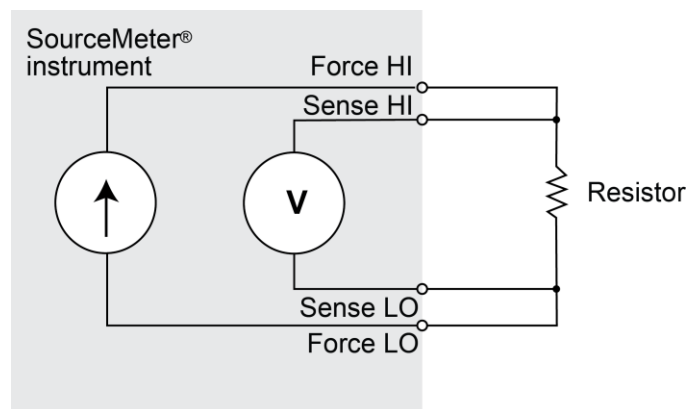

You can use either the front-panel or the rear-panel terminals for this application. The following figures show the physical connections for the front and rear panels. Note that you must use either the front-panel terminals or rear-panel terminals — you cannot mix connections.

When you connect the leads to the device under test (DUT), notice that the FORCE LO and SENSE LO connections are attached to one of the DUT leads. Make the FORCE HI and SENSE HI connections to the other lead. Connect the sense connections as close to the resistor under test as possible. This 4-wire measurement eliminates the resistance of the test leads in the measurement.

The figure below shows the front-panel connections. You can make these connections with four insulated banana cables that are rated to the maximum current (7 A), such as two sets of the Keithley Instruments Model 8608 High-Performance Clip Lead Set.

**Figure 22: 2460 front-panel connections for low-resistance measurements**

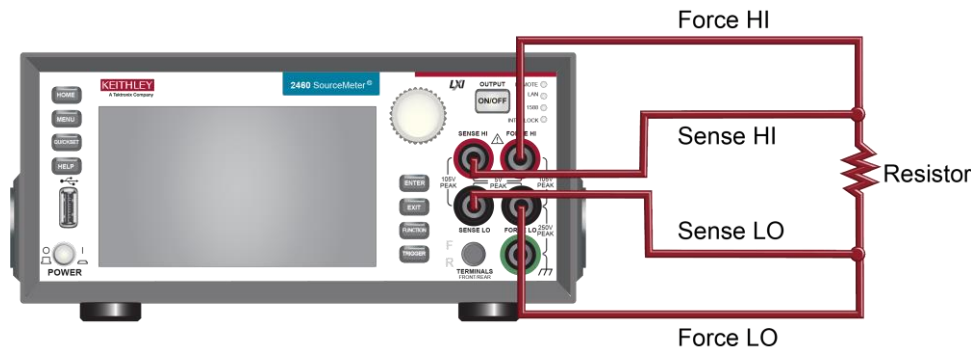

The figure below shows the rear-panel connections. You can make these connections with either the Model 2460-KIT Screw-Terminal Connector Kit (included with the 2460) or a Model 2460-BAN Banana Test Leads/Adapter Cable with appropriate cabling.

**Figure 23: 2460 low-resistance connections on rear panel**

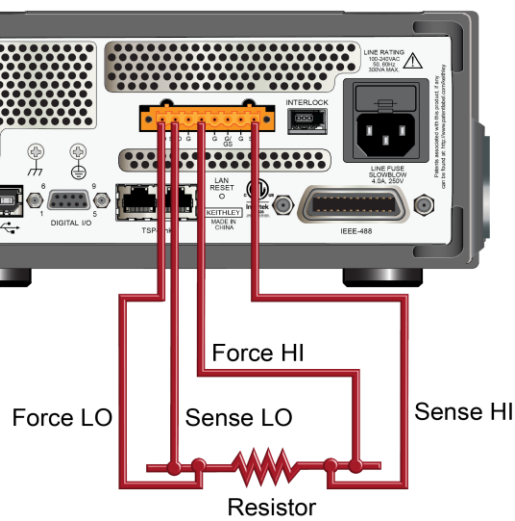

## Low-resistance measurements

This application demonstrates how to use the 2460 to measure a low-resistance device. You can measure from the front panel or over the remote interface using SCPI code or TSP code.

For this application, you will:

- Turn on the instrument.
- Select the source current and measure resistance function.
- Set the current source value.
- Select four-wire (remote sense) mode. This eliminates the effect of lead resistance on measurement accuracy.
- Enable offset compensation. This reduces offset caused by thermoelectric voltages. For information about offset compensation, see “What is offset compensation?” in the *Model 2460 Reference Manual*.
- Turn on the source output and start making measurements.
- Generate readings from the front panel or the remote interface.
- Turn the source output off.



## Set up the measurement from the front panel

### To set up the application from the front panel:

1. Make connections from the 2460 to the device under test, as described in [Device connections](#) (on page 5-2).
2. Turn on the instrument.
3. Press the **FUNCTION** key.
4. Under Source Current and Measure, select **Resistance**. A warning message is displayed.
5. Select **OK** to clear the error message.
6. Press the **HOME** key.
7. In the SOURCE I area, select the button next to Source. Select a source value appropriate to your device.
8. Press the **MENU** key. Under Measure, select **Settings**.
9. Set Sense to **4-Wire Sense**.
10. Set Offset Compensation to **On**.
11. Press the **HOME** key.
12. Press the **OUTPUT ON/OFF** switch to enable the output.
13. Select the **Measurement Method** indicator.
14. Select **Continuous Measurement** to start making measurements. The instrument displays the measurements in the MEASURE VOLTAGE area of the home screen.

Figure 24: Measurement Method indicator with Continuous Measurement selected

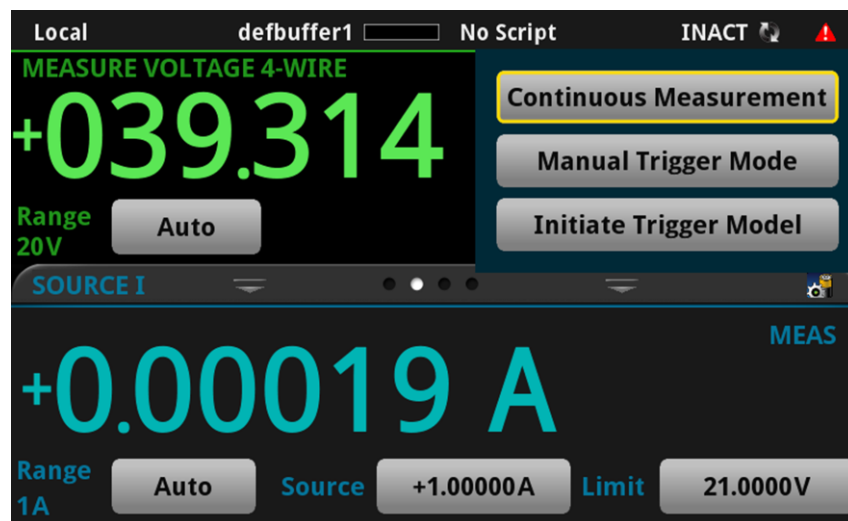

15. Press the **OUTPUT ON/OFF** switch to disable the output and stop making measurements.

## View the measurements on the front-panel GRAPH swipe screen

You can view the resistance measurements as a function of time on the front-panel GRAPH swipe screen. To access the GRAPH swipe screen, swipe the bottom part of the home screen to the right. A graph similar to the one in the figure below is displayed.

Figure 25: GRAPH swipe screen

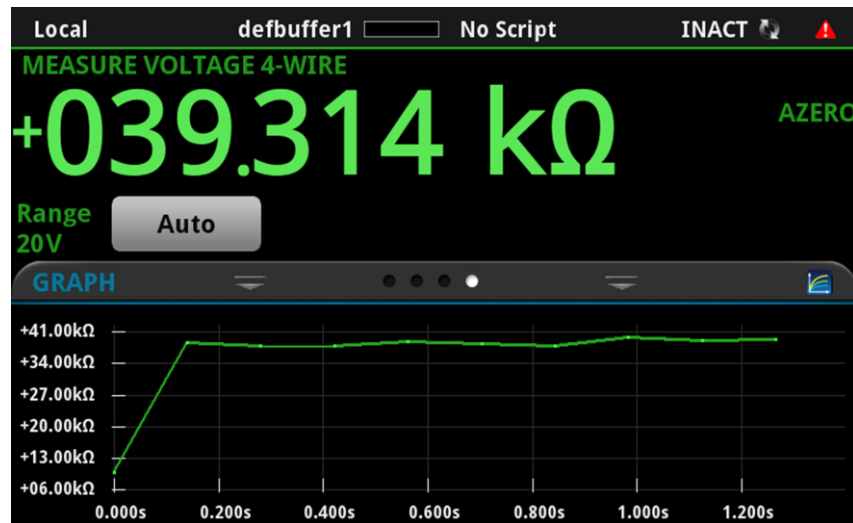

To see the graph on the full screen, touch the graph icon on the GRAPH swipe bar to open the Graph screen.

## View the buffer statistics on the front panel

You can view the measurement statistics on the 2460 front-panel STATISTICS swipe screen, including:

- Peak-to-peak value
- Minimum, maximum, and average reading values
- Standard deviation

To view the statistics, from the home screen, swipe to the STATISTICS screen.

Figure 26: 2460 STATISTICS swipe screen



## Set up the low-resistance application using SCPI commands

The following sequence of SCPI commands makes 100 low-resistance measurements by sourcing current and measuring resistance. In this example, the source current magnitude and limit voltage are set automatically. It uses remote commands to change the front-panel display to show the GRAPH swipe screen. This allows you to view numeric data at the top of the screen and graphic data at the bottom of the screen.

You may need to make changes so that this code will run in your programming environment.

**Send the following commands for this example application:**

Command	Description
<pre>*RST TRIG:LOAD "SimpleLoop", 100 SENS:FUNC "RES" SENS:RES:RANG:AUTO ON SENS:RES:OCOM ON SENS:RES:RSEN ON DISP:SCR SWIPE_GRAPH OUTP ON INIT *WAI OUTP OFF TRAC:DATA? 1, 100, "defbuffer1", READ, REL</pre>	<ul style="list-style-type: none"><li>▪ Reset the 2460.</li><li>▪ Configure Simple Loop trigger-model template to make 100 readings.</li><li>▪ Set to measure resistance.</li><li>▪ Turn on auto range.</li><li>▪ Enable offset compensation.</li><li>▪ Set to use 4-wire sense mode.</li><li>▪ Show the GRAPH swipe screen.</li><li>▪ Turn on the output.</li><li>▪ Initiate readings.</li><li>▪ Wait until finished.</li><li>▪ Turn off the output.</li><li>▪ Read the resistance and time values from defbuffer1.</li></ul>

## Set up the low-resistance application using TSP commands

The following TSP code is designed to be run from Keithley Instruments Test Script Builder (TSB). TSB is a software tool that is available from [tek.com/keithley](http://tek.com/keithley). You can install and use TSB to write code and develop scripts for TSP-enabled instruments. Information about how to use TSB is in the online help for TSB and in the “Introduction to TSP operation” section of the *Model 2460 Reference Manual*.

To use other programming environments, you may need to make changes to the example TSP code.

By default, the 2460 uses the SCPI command set. You must select the TSP command set before sending TSP commands to the instrument.

### **To enable TSP commands:**

1. Press the **MENU** key.
2. Under System, select **Settings**.
3. Set the Command Set to **TSP**.
4. At the prompt to reboot, select **Yes**.

This sequence of TSP commands makes 100 low-resistance measurements by sourcing current and measuring resistance. In this example, the source current magnitude and limit voltage are set automatically. It uses remote commands to change the front-panel display to show the GRAPH swipe screen. This allows you to view numeric data at the top of the screen and graphic data at the bottom of the screen. After the code executes, the data is displayed in the Instrument Console of Test Script Builder.

**Send the following commands for this example application:**

```
-- Reset the instrument to the default settings
reset()
-- Configure the Simple Loop trigger-model template to make 100 readings.
trigger.model.load("SimpleLoop", 100)
-- Change the view on the front panel to the GRAPH swipe screen.
display.changescreen(display.SCREEN_GRAPH_SWIPE)
-- Set to measure resistance, use 4-wire sense,
-- and offset compensation.
smu.measure.func = smu.FUNC_RESISTANCE
smu.measure.sense = smu.SENSE_4WIRE
smu.measure.offsetcompensation = smu.ON
-- Turn on the output
smu.source.output = smu.ON
-- Initiate trigger model and wait until finished.
trigger.model.initiate()
waitcomplete()
-- Turn off output
smu.source.output = smu.OFF
-- Read the resistance and time values from defbuffer1.
print("Resistance:\tTime:")
for i = 1, 100 do
    print(string.format("%f\t%f", defbuffer1[i], defbuffer1.relativetimestamps[i]))
end
```

---

## Rechargeable battery measurements

### In this section:

Introduction.....	6-1
Equipment required .....	6-3
Device connections .....	6-4
Automated battery charge and discharge cycle testing .....	6-7

## Introduction

This example application demonstrates how to use a single 2460 to perform automated battery discharge and charge cycle testing.

---

### **WARNING**

To prevent personal injury or damage to the 2460, do not attempt to charge nonrechargeable batteries. Some of the batteries that can be charged with a 2460 are nickel cadmium (Ni-Cd), nickel metal hydride (Ni-MH), lithium ion (Li-ion), rechargeable alkaline, and lead acid. If you are working with a battery type that is not listed here, please contact your local Keithley office, sales partner, or distributor, or call one of our Applications Engineers to get technical assistance.

Always follow the battery manufacturer's requirements for charging or discharging batteries using a 2460. Failure to properly charge or discharge batteries may cause them to leak or explode, resulting in personal injury and property damage. Overvoltage and current protection should be provided in the charge circuit, external to the instrument, when charging batteries without built-in protection.

Do not charge or discharge batteries that exceed 100 V at 1 A, 20 V at 4 A, 10 V at 5 A, or 7 V at 7 A.

---

For both the charging and discharging cycles, you configure the 2460 to source voltage and measure current. The following figures show simplified schematics for the charge and discharge cycles.

**Figure 27: Model 2460 charge-discharge cycle**

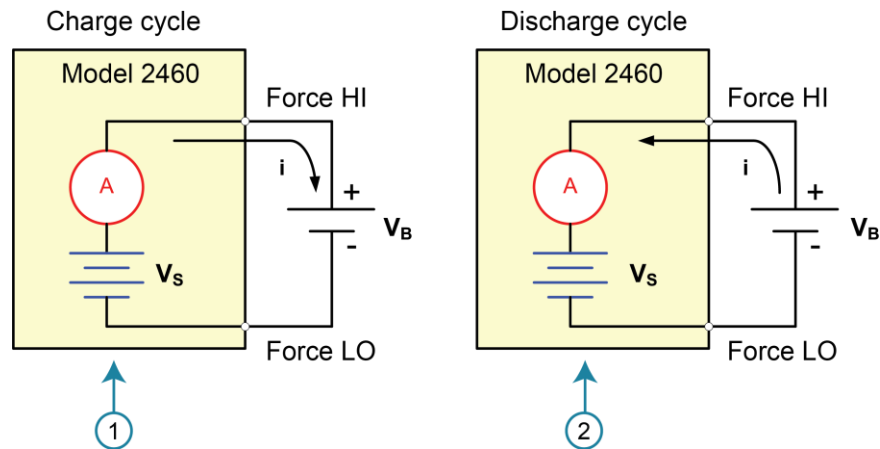

1	2460 is in source mode ( $V_s > V_B$ ). Instrument functions as a power supply; charge current ( $i$ ) is positive.
2	2460 is in sink mode ( $V_s < V_B$ ). Instrument functions as an electronic load; discharge current ( $i$ ) is negative.

### Charging

A battery is usually charged using a constant current. To do this, use a 2460 as a voltage source set to the voltage rating of the battery, with the target charging current set as the current limit. At the start of the test, the battery voltage is less than the voltage output setting of the 2460. As a result, this voltage difference drives a current that is immediately limited to the user-defined current limit. When in current limit, the 2460 acts as a constant current source until it reaches the programmed voltage level. As the battery becomes fully charged, the current decreases until it reaches zero or near zero. To prevent safety hazards or damage to the battery, be careful not to overcharge the battery.

### Discharging

When discharging a battery, the 2460 operates as a sink because it is dissipating power instead of sourcing it. The voltage source of the 2460 is set to a lower level than the battery voltage. The current limit sets the discharge rate. When the output is enabled, the current from the battery flows into the HI terminal of the 2460. As a result, the current readings are negative. The discharge current should stay constant until the battery voltage decreases to the voltage source setting of the 2460.



---

## CAUTION

If you are using the current source to charge or discharge batteries, the following precautions must be observed. Failure to observe these precautions could result in instrument damage that is not covered by the warranty.

**Make sure the external voltage never exceeds the voltage limit setting of the current source. This will cause excessive current to be drawn from the external battery or source.**

**Be sure to set the output-off state of the current source for high impedance. This setting opens the output relay when the output is turned off. With the normal output-off state selected, turning the output off sets the voltage limit to zero. This 0 V source limit condition will cause excessive current to be drawn from the external battery or source.**

**Carefully consider and configure the output-off state, source, and limits before connecting the 2460 to a device that can deliver energy. Devices that can deliver energy include voltage sources, batteries, capacitors, and solar cells. Configure instrument settings before making connections to the device. Failure to consider the output-off state, source, and limits may result in damage to the instrument or to the device under test (DUT).**

**When using the current source as a sink, always set the voltage limit and configure overvoltage protection (OVP) to levels that are higher than the external voltage level. Failure to do so could result in excessive current flow into the 2460 (> 100 mA) and incorrect measurements. When the instrument is operating in limit, be aware that the instrument always tries to maintain the limit.**

---

## Equipment required

- One 2460 High-Current SourceMeter® Instrument
- For front-panel connections, use four insulated banana cables, such as the Keithley Instruments Model 8608 High-Performance Clip Lead Set (one set included with the 2460; you will need another set)
- For rear-panel connections, use one Model 2460-KIT Screw-Terminal Connector Kit (provided with the 2460), or you can use one set of Model 2460-BAN Banana Test Leads/Adapter Cables (with appropriate connections to the device)
- One GPIB, USB, or ethernet cable to connect the 2460 to a computer
- One rechargeable 2500 mAh D (1.2 V) battery to test

## Device connections

To set up the test, connect the 2460 to the battery as shown in the following figure. Make a 4-wire (remote sense) connection from the instrument terminals to the battery to eliminate the effects of the lead resistance. This allows you to measure the battery voltage as closely as possible to the terminals of the instrument.

Figure 28: Schematic for the Model 2460 battery application

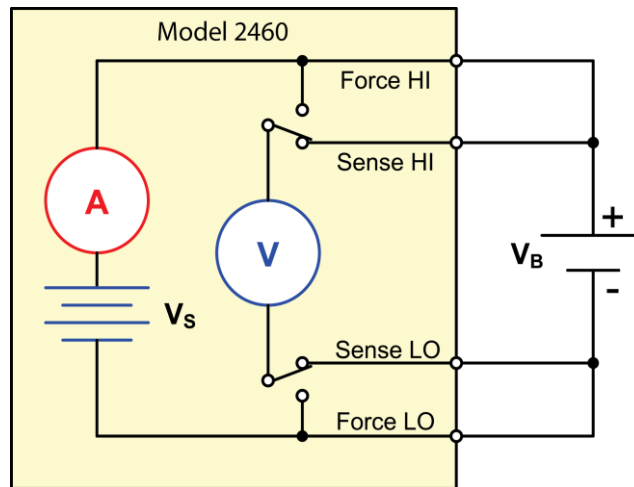

### **⚠ WARNING**

To prevent electric shock, test connections must be configured such that the user cannot come in contact with conductors or any device under test (DUT) that is in contact with the conductors. It is good practice to disconnect power before connecting DUTs. Safe installation requires proper shields, barriers, and grounding to prevent contact with conductors.

There is no internal connection between protective earth (safety ground) and the LO terminals of the 2460. Therefore, hazardous voltages (more than  $30 V_{RMS}$ ) can appear on LO terminals. This can occur when the instrument is operating in any mode. To prevent hazardous voltage from appearing on the LO terminals, connect the LO terminal to protective earth (safety ground) if your application allows it. You can connect the LO terminal to the chassis ground terminal on the front panel or the chassis ground screw terminal on the rear panel. Note that the front-panel terminals are isolated from the rear-panel terminals. Therefore, if you are using the front-panel terminals, ground to the front-panel LO terminal. If using the rear-panel terminals, ground to the rear panel LO terminal. Failure to follow these guidelines can result in injury, death, or instrument damage.

## NOTE

On some sensitive or easily damaged devices under test (DUTs), the instrument power-up and power-down sequence can apply transient signals to the DUT that may affect or damage it. When testing this type of DUT, do not make final connections to it until the instrument has completed its power-up sequence and is in a known operating state. When testing this type of DUT, disconnect it from the instrument before turning the instrument off.

To prevent any human contact with a live conductor, connections to the DUT must be fully insulated and the final connections to the DUT must only use safety-rated safety jack socket connectors that do not allow bodily contact.

You can make test connections to the 2460 from the rear or front panel of the instrument.

Connect the FORCE HI and SENSE HI output terminals of the 2460 to the positive (+) terminal of the battery. Connect the SENSE LO and FORCE LO outputs to the negative (–) terminal of the battery.

Make sure that when the output of the 2460 is turned off, it is set to the high-impedance (High-Z) output-off state. When the high-impedance output-off state is selected, the output relay opens when the output is turned off. This prevents the battery from draining when the output is off.

### ***To set the output-off state to high impedance:***

1. Press the **MENU** key.
2. In the Source column, select **Settings**.
3. Set Output Off to **High Impedance**.
4. Press the **HOME** key to return to the home screen.

The figure below shows the front-panel connections. You can make these connections with four insulated banana cables that are rated to the maximum current (7 A), such as two sets of the Keithley Instruments Model 8608 High-Performance Clip Lead Set.

**Figure 29: Front-panel connections for the battery discharge-charge application**

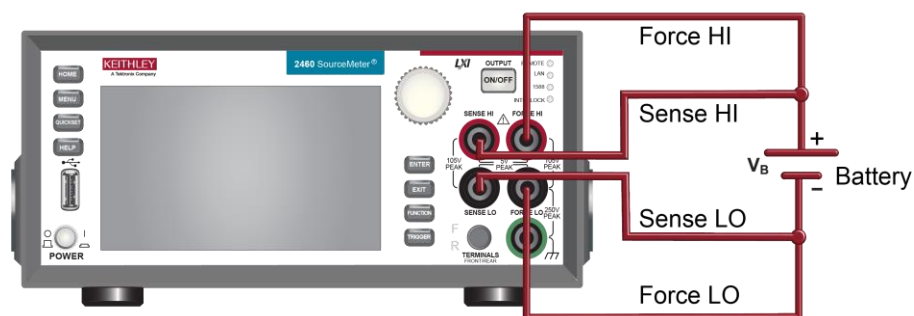

The figure below shows the rear-panel connections. You can make these connections with either the Model 2460-KIT Screw-Terminal Connector Kit (included with the 2460) or a Model 2460-BAN Banana Test Leads/Adapter Cable with appropriate cabling.

**Figure 30: Rear-panel connections for the battery discharge-charge application**

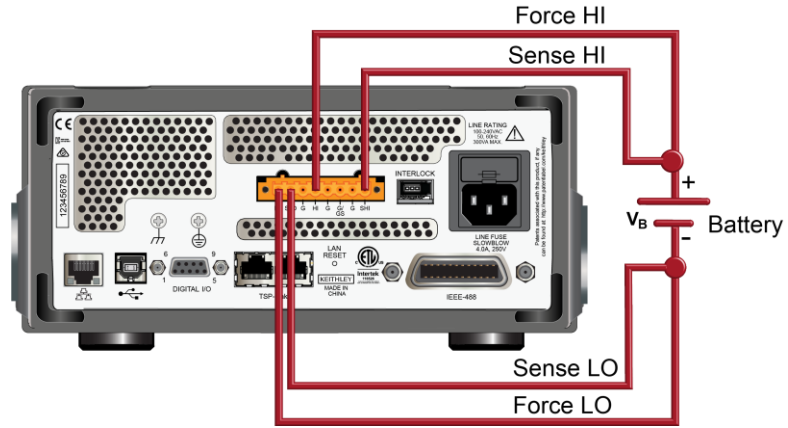

## Automated battery charge and discharge cycle testing

Battery charge and discharge cycles often take several hours, so automating the test is important. This example demonstrates how to use the 2460 to perform an automated battery discharge test using SCPI commands or TSP commands.

For this application, you will:

- Reset the instrument.
- Set the measurement to a 4-wire configuration.
- Set the instrument to source voltage and measure current.
- Select the high impedance output-off mode, which opens the output relay when the 2460 output is turned off. Select this mode before connecting the battery to the output. This prevents the battery from draining when it is connected to the instrument with the output off.
- Set the current limit to the current level at which the battery is to be charged or discharged. This is the load current of the test. Even though the 2460 is sourcing voltage, it operates in constant current mode because it is in current limit until it reaches the desired voltage.
- Turn on source readback to enable the 2460 to measure the battery voltage while it either charges or discharges.
- Read the load current, source readback voltage, and the relative timestamp.
- Monitor the voltage until the battery voltage reaches the specified voltage level and stop the test.

To charge the battery, program the 2460 to output a voltage that is equivalent to the voltage rating of the battery. For example, to charge a 10 V battery, set the 2460 to source 10 V. As the battery fully charges, current decreases until it reaches zero or near zero (battery charged).

To discharge the battery, program the 2460 to output a voltage to a lower level than the battery voltage and set the output-off state to high impedance. In this configuration, the 2460 operates as a sink to discharge the battery. Current from the battery flows into the SENSE HI terminal of the 2460, which results in negative current measurements. As the battery discharges, the current stays constant.

## Set up remote communications

This application is configured to run remotely. You can run this application from any of the supported communication interfaces for the instrument (GPIB, USB, or ethernet).

The following figure shows the rear-panel connection locations for the remote communication interfaces.

**Figure 31: 2460 remote interface connections**

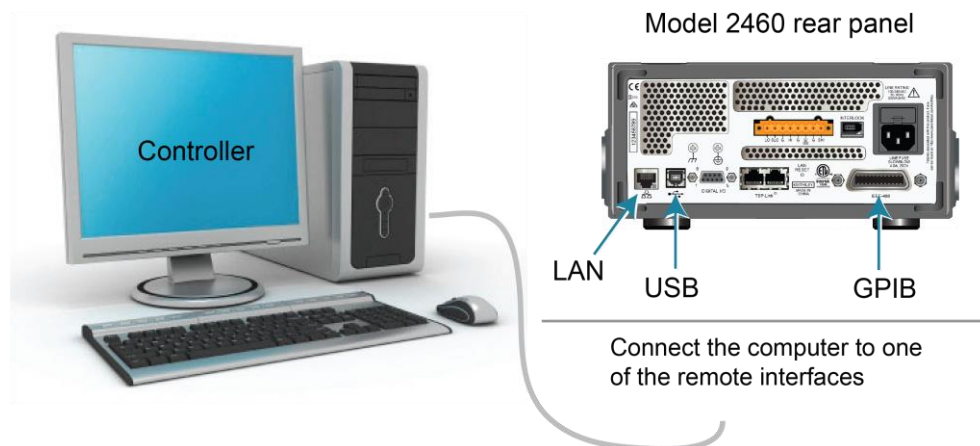

## Set up the battery application using SCPI commands

The SCPI code in this example is configured to discharge a fully charged 1.2 V (2500 mAh) battery to 0.9 V. The 2460 is configured to source voltage and measure current. Specifically, the voltage source is set to 0.9 V and the source limit is set to 2.5 A. The voltage, current, and relative timestamp values are returned. Measurements are made until the voltage reaches the set level.

---

### NOTE

You may need to change the current and voltage levels so that they are appropriate for the battery you are testing.

---

In the following example code, notice that some of the code is labeled as "Pseudocode." The code you use for the pseudocode lines will vary based on the programming environment you use.

**Send the following commands for this example application:**

SMU command or pseudocode	Commands	Description
SMU command	<pre> OUTP:SMOD HIMP SENS:CURR:RSEN ON SOUR:FUNC VOLT SOUR:VOLT 0.9 ROUT:TERM REAR SOUR:VOLT:READ:BACK ON SOUR:VOLT:RANG 2 SOUR:VOLT:ILIM 2.5 SENS:FUNC "CURR" SENS:CURR:RANG 4 OUTP ON </pre>	<ul style="list-style-type: none"> <li>■ Turn on high-impedance output mode.</li> <li>■ Set to 4-wire sense mode.</li> <li>■ Set to source voltage.</li> <li>■ Set source level to 0.9 V.</li> <li>■ Select the rear-panel connections.</li> <li>■ Turn on source readback.</li> <li>■ Set source range to 2 V.</li> <li>■ Set the source limit to 2.5 A.</li> <li>■ Set to measure current.</li> <li>■ Set current range to 4 A.</li> <li>■ Turn the output on.</li> </ul>
Pseudocode	<pre> iteration = 1 voltLimit = 0.9001 current = [] voltage = [] seconds = [] hours = [] while true do: </pre>	<ul style="list-style-type: none"> <li>■ Create a variable called <code>iteration</code> and initialize to 1.</li> <li>■ Create a variable called <code>voltLimit</code> and initialize to 0.9001.</li> <li>■ Create an empty array for current measurements.</li> <li>■ Create an empty array for voltage measurements.</li> <li>■ Create empty arrays for the time values.</li> <li>■ Start a <code>while</code> loop.</li> </ul>
SMU command	<pre> current[iteration] = READ? "defbuffer1" voltage[iteration] = TRAC:DATA? iteration, iteration, "defbuffer1", SOUR seconds[iteration] = TRAC:DATA? iteration, iteration, "defbuffer1", REL </pre>	<ul style="list-style-type: none"> <li>■ Append the current reading to the array <code>current</code>.</li> <li>■ Append the voltage reading to the array <code>voltage</code>.</li> <li>■ Append the time reading to the array <code>seconds</code>.</li> </ul>
Pseudocode	<pre> hours[iteration] = seconds[iteration]/3600 print(voltage[iteration], current[iteration], hours[iteration]) if voltage[iteration] &lt;= voltLimit then: break end if iteration = iteration + 1 delay(10) end while </pre>	<ul style="list-style-type: none"> <li>■ Calculate the hours taken at each iteration.</li> <li>■ Print the measured values.</li> <li>■ Compare the voltage reading from this iteration to the voltage limit. If the measured value is less than or equal to the limit, break out of the loop.</li> <li>■ End the <code>if</code> statement.</li> <li>■ Increment the iteration count by 1.</li> <li>■ Delay for 10 seconds.</li> <li>■ End the <code>while</code> loop.</li> </ul>
SMU command	<pre> OUTP OFF </pre>	<ul style="list-style-type: none"> <li>■ Turn the output off.</li> </ul>

## Set up the battery application using TSP commands

The following TSP code is designed to be run from Keithley Instruments Test Script Builder (TSB). TSB is a software tool that is available from [tek.com/keithley](http://tek.com/keithley). You can install and use TSB to write code and develop scripts for TSP-enabled instruments. Information about how to use TSB is in the online help for TSB and in the “Introduction to TSP operation” section of the *Model 2460 Reference Manual*.

To use other programming environments, you may need to make changes to the example TSP code.

By default, the 2460 uses the SCPI command set. You must select the TSP command set before sending TSP commands to the instrument.

### **To enable TSP commands:**

1. Press the **MENU** key.
2. Under System, select **Settings**.
3. Set the Command Set to **TSP**.
4. At the prompt to reboot, select **Yes**.

The TSP code in this example sets the 2460 to the source voltage function and measure current function. To discharge a fully charged 1.2 V battery, the voltage source is set to 0.9 V and the source limit is set to 2.5 A. The voltage, current, and relative timestamp values are returned. Measurements are made until the voltage reaches the set level. During the test, these measurements are shown on the USER swipe screen at the bottom of the screen. See [Battery application test results](#) (on page 6-13) for an example.

---

## NOTE

You may need to change the current and voltage levels so that they are appropriate for the battery you are testing.

---

This application refers to the discharge current rate of 1C. Discharge current can be expressed as a C-rate to normalize against different battery capacities. A C-rate is a measure of the rate at which a battery is discharged relative to its maximum capacity. 1C means that the discharge current discharges the entire battery in 1 hour.



The TSP code in this example also saves all of the current, voltage, and time readings to a USB flash drive connected to the 2460 front panel.

Before connecting the battery to the output terminals, complete the following tasks to prepare the 2460 for the test.

***Reset the instrument:***

1. Press the **MENU** key.
2. Under System, select **Info/Manage**.
3. Select **System Reset**.
4. Select **OK**.

***Set the output-off state to High Impedance:***

1. Press the **MENU** key.
2. Under Source, select **Settings**.
3. Set Output Off to **High Impedance**.

The High Impedance output-off state opens the output relay when the output is turned off, which prevents the battery from draining.

**Send the following TSP commands for this example application:**

```
-- This code discharges a 2500 mAh 1.2 V battery to 0.9 V with a
-- discharge current of 2.5 A (1C).
-- Before using this code, reset the instrument from the front panel
-- and set the output-off state of the 2460 to High Impedance
-- (High Z). Also, insert a USB flash drive in the front-panel USB
-- port to save your readings.

-- Clear the buffer.
defbuffer1.clear()
-- Measurement settings.
smu.measure.func = smu.FUNC_DC_CURRENT
smu.measure.range = 4.0
smu.measure.sense = smu.SENSE_4WIRE
-- Source settings.
smu.source.func = smu.FUNC_DC_VOLTAGE
smu.source.offmode = smu.OFFMODE_HIGHZ
smu.source.level = 0.9
smu.terminals = smu.TERMINALS_REAR
smu.source.range = 2.0
smu.source.readback = smu.ON
smu.source.ilimit.level = 2.5
-- Set the voltage limit for the battery to stop discharging.
-- Set the variable for the number of iterations.
voltLimit = 0.9001
iteration = 1
-- Turn on the source output.
smu.source.output = smu.ON
-- Change the display to the USER swipe screen.
display.changescreen(display.SCREEN_USER_SWIPE)
-- Keep making readings in the while loop until the measured voltage
-- is equal to the voltage limit.
while true do
    -- Make a reading and get the current, voltage, and relative timestamp.
    curr = smu.measure.read(defbuffer1)
    volt = defbuffer1.sourcevalues[iteration]
    time = defbuffer1.relativetimestamps[iteration]
    hours = time/3600
    -- Compare the measured voltage to the voltage limit.
    -- Exit the loop if it has reached the limit.
    if volt <= voltLimit then
        break
    end
-- Print the number of completed cycles, the voltage, and the time for the
-- iteration. Display the information on the front panel.
print("Completed Cycles: ", iteration, "Voltage: ", volt, "Time: ", time)
display.settext(display.TEXT1, string.format("Voltage = %.4fV", volt))
display.settext(display.TEXT2, string.format("Current = %.2fA, Time = %.2fHrs",
curr, hours))
-- Increment the number of iterations and wait 10 seconds.
iteration = iteration + 1
delay(10)
end
-- Turn the output off when the voltage limit is reached.
smu.source.output = smu.OFF
```

```

-- Save the measurements to the USB flash drive.
FileNumber = file.open("/usb1/TestData.csv", file.MODE_WRITE)
file.write(FileNumber, "Current, Voltage, Seconds\n")
-- Print the measured values in a four-column format.
print("\nIteration:\tCurrent:\tVoltage:\tTime:\n")
for i = 1, defbuffer1.n do
  print(i, defbuffer1[i], defbuffer1.sourcevalues[i],
    defbuffer1.relativetimestamps[i])
  file.write(FileNumber, string.format("%g,%g, %g\r\n", defbuffer1.readings[i],
    defbuffer1.sourcevalues[i], defbuffer1.relativetimestamps[i]))
end
-- Close the .csv file.
file.close(FileNumber)

```

## Battery application test results

Figure 32: 2460 USER swipe screen showing test results

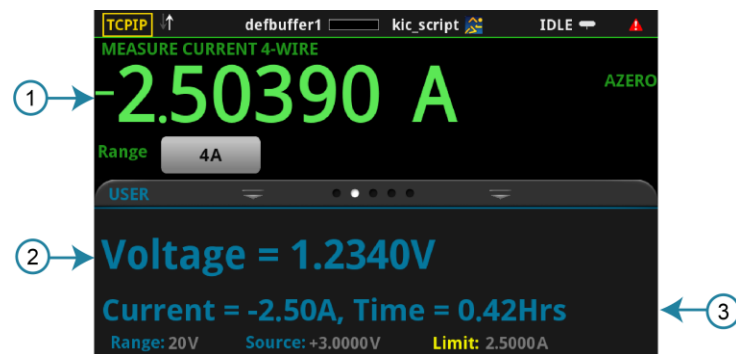

1	Measured load current
2	Measured battery voltage
3	Source value and elapsed test time

**Figure 33: Results of battery discharge test**

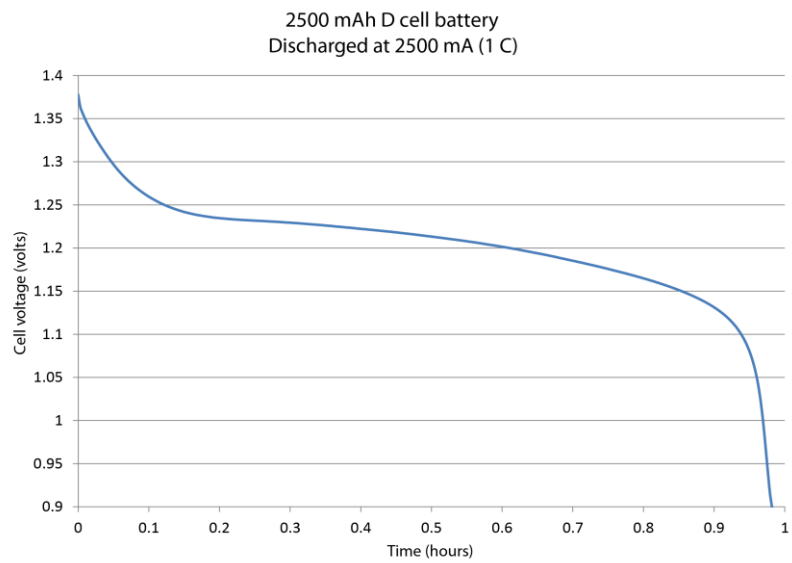

---

## Generate an I-V sweep on an LED

### In this section:

Introduction.....	7-1
Equipment and software required.....	7-2
Set up remote communications .....	7-2
Device connections .....	7-3
Generate an I-V sweep using KickStart.....	7-5

## Introduction

This example application demonstrates how to generate a current-voltage sweep on a high-brightness LED using the Keithley KickStart Software and a 2460. KickStart allows you to set up your instrument and run a test quickly without writing any code. The data generated by KickStart can be plotted on a graph or viewed in a table. The measurements can also be saved to a file in `.csv` file format.

In this example, you will use KickStart to configure the 2460 to output a voltage sweep and measure the resulting current on a high-brightness LED. You will then run the test and graph the data in KickStart.

## Equipment and software required

- One 2460 High-Current SourceMeter® Instrument
- Keithley KickStart Software version 2.1 or later installed on your computer; you can download a trial of the KickStart software from the [Keithley Instruments support website \(tek.com/support\)](http://tek.com/support)
- For front-panel connections, use four insulated banana cables, such as the Keithley Instruments Model 8608 High-Performance Clip Lead Set (one set included with the 2460; you will need another set)
- For rear-panel connections, use one Model 2460-KIT Screw-Terminal Connector Kit (provided with the 2460), or you can use one set of Model 2460-BAN Banana Test Leads/Adapter Cables (with appropriate connections to the device)
- One GPIB, USB, or ethernet cable to connect the 2460 to a computer
- One high-brightness LED

## Set up remote communications

This application is configured to run remotely. You can run this application from any of the supported communication interfaces for the instrument (GPIB, USB, or ethernet).

The following figure shows the rear-panel connection locations for the remote communication interfaces.

**Figure 34: 2460 remote interface connections**

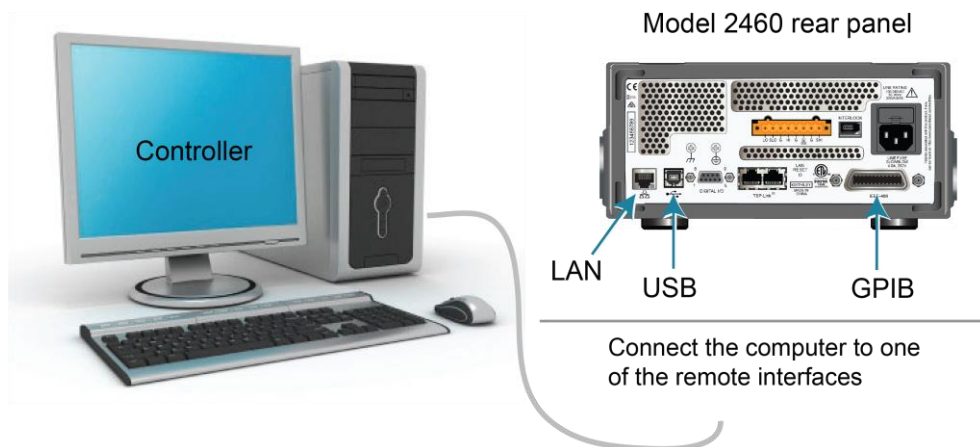

## Device connections

For best measurement accuracy and to eliminate the effects of test lead resistance when sourcing high current, connect the 2460 to the device under test (DUT) using the 4-wire sense method.

**To use the 4-wire sense connection method:**

- Connect the FORCE HI and SENSE HI leads to the anode terminal of the LED.
- Connect the FORCE LO and SENSE LO leads to the cathode terminal of the LED.
- Make the connections as close to the DUT as possible to exclude the test-lead resistance from the measurement.

The following figure shows the schematic for testing a high-brightness LED.

**Figure 35: Model 2460 4-wire connections to an LED**

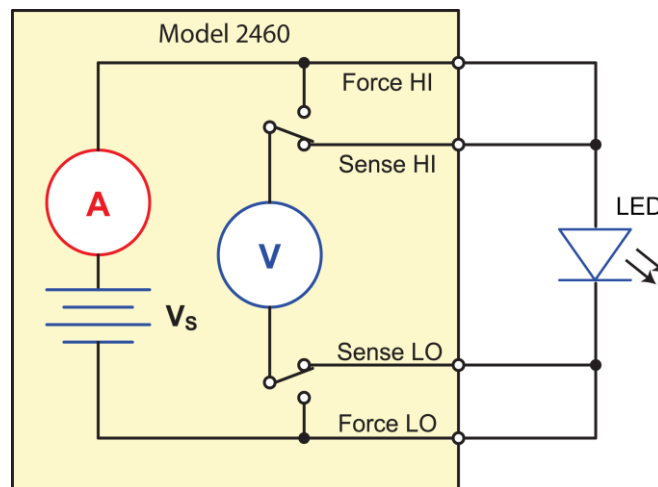

The following figures show the physical connections for the front and rear panels. Note that you must use either the front-panel terminals or rear-panel terminals — you cannot mix connections.

The figure below shows the front-panel connections. You can make these connections with four insulated banana cables that are rated to the maximum current (7 A), such as two sets of the Keithley Instruments Model 8608 High-Performance Clip Lead Set.

**NOTE**

Turn the power to the instrument off before attaching connections to the 2460.

**Figure 36: 2460 4-wire front-panel connections to an LED**

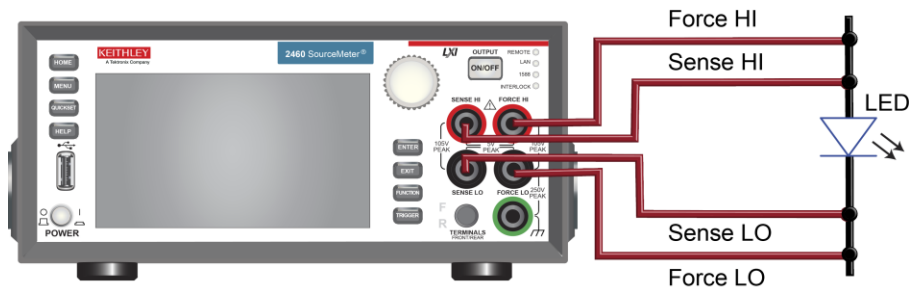

The figure below shows the rear-panel connections. You can make these connections with either the Model 2460-KIT Screw-Terminal Connector Kit (included with the 2460) or a Model 2460-BAN Banana Test Leads/Adapter Cable with appropriate cabling.

**Figure 37: 2460 4-wire rear-panel connections to an LED**

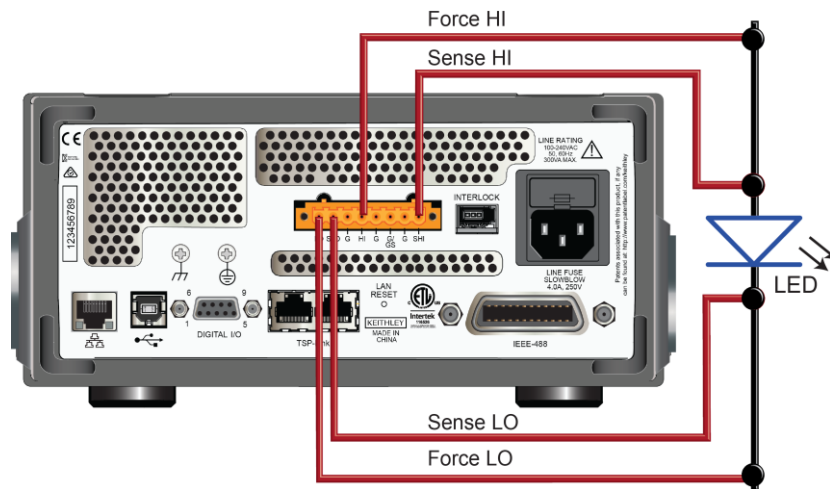



## Generate an I-V sweep using KickStart

This example application uses Keithley KickStart Software to generate a current-voltage sweep on a high-brightness LED.

In this example application, you will:

- Launch the KickStart software
- Create a new test project
- Select an instrument
- Select a test type
- Configure the test parameters
- Configure and view the graph screen
- Run the test
- View and save the test data

## Configure the 2460 to use the KickStart software

The 2460 must be set to use the Test Script Processor (TSP®) command set before you can use the KickStart software. By default, the 2460 uses the SCPI command set. You must select the TSP command set before using KickStart.

### *To enable TSP commands:*

1. Press the **MENU** key.
2. Under System, select **Settings**.
3. Set the Command Set to **TSP**.
4. At the prompt to reboot, select **Yes**.

## Launch KickStart and set up the test

You are ready to launch the KickStart software.

### ***To create a new test project:***

1. Launch the KickStart software. KickStart opens, as shown in the following figure. KickStart automatically detects connected instruments.

**Figure 38: KickStart Software Start Page**

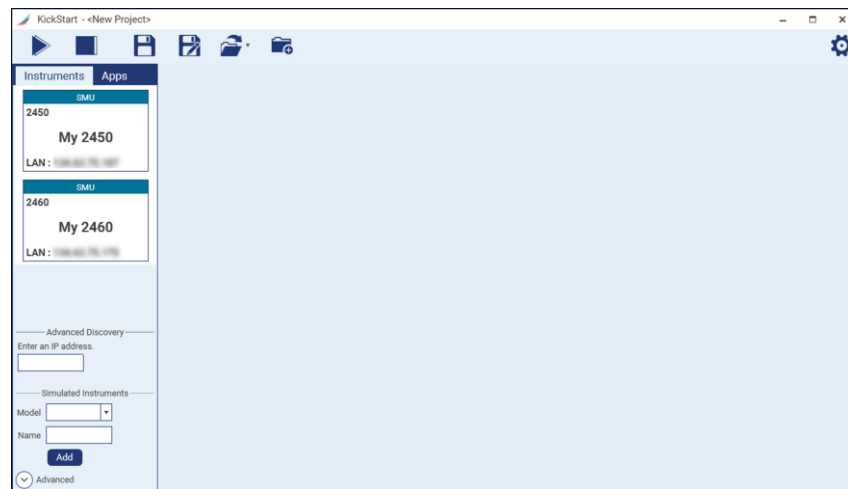

2. Select the 2460 in the Instruments panel.
3. Select **Save Project**.
4. Select a location or use the default location.
5. Enter a name for the test and select **Save**. The test is saved as a `.ksp` file in a folder with the name of the test project.
6. Double-click the 2460 in the Instruments panel. The Select an App dialog box is displayed.
7. Select the **IV Characterizer** app and select **OK**. The Settings screen opens.
8. Use the values in the following tables to specify the source and measure parameters for this application (you can change these values for your own application).

**Source settings**

Parameter	Value
Source Mode	Voltage Sweep
Sweep Type	Linear
Start Voltage	2
Stop Voltage	3.7
Step Voltage	0.05
# Of Steps	This is automatically completed based on the step voltage setting. For this example, the value is 35.
Current Limit	7
Delay Seconds	0.01

**Measure settings**

Parameter	Value
Current Measure	Enabled, Auto Range
Voltage Measure	Enabled, Programmed Value

9. In the lower part of the Measure Settings column, select **Advanced Configuration** and set the parameters listed in the following table.

**Advanced settings**

Parameter	Value
Input Terminals	Rear or front, depending on connections
Sensing Mode	4-Wire
Output OFF State	Normal
High Capacitance	Off

You are now ready to run the test.

## Run the test and view the graph

To run the test, select the Run icon in the upper left corner of the screen. An I-V sweep is generated automatically and the results appear in real time on the graph screen. The data on the graph is scaled automatically as the test progresses.

The following figure shows the result of running this example application.

**Figure 39: Results of running an I-V sweep on a high-brightness LED**

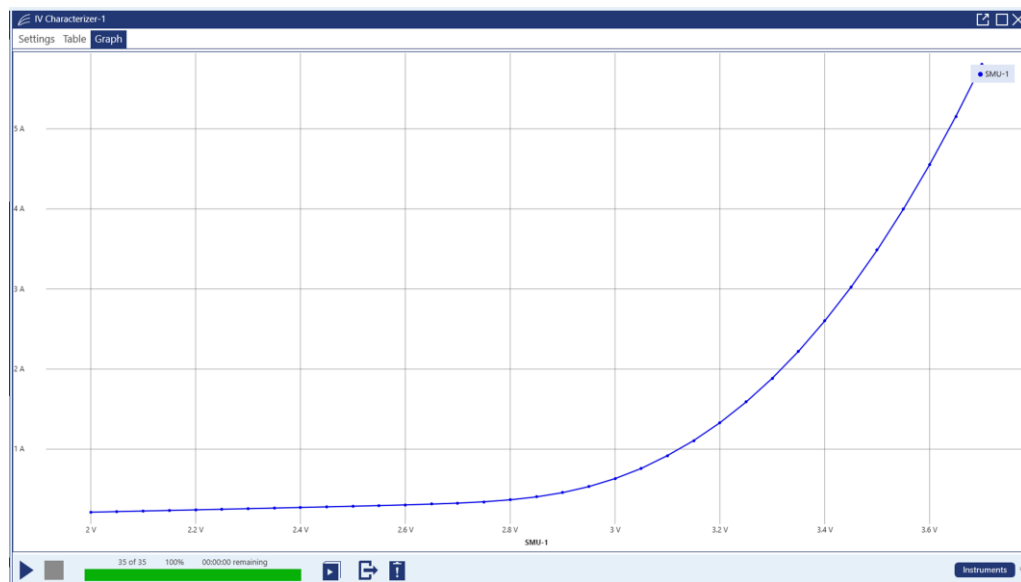

To save the graph as a .png file, select the Export icon (see the following figure) or right-click the graph and select **Save As Image**.

**Figure 40: Export icon**



## View and save the test data in tabular form

You can also view the results of the test in tabular form by selecting the **Table** tab. The figure below shows the test results on the Table tab.

**Figure 41: Test data on the KickStart Table tab**

IV Characterizer-1				
Settings <b>Table</b> Graph				
SMU-1				
	Time (s)	Voltage (V)	Current (A)	
11	305.547e-3	2.50000	281.433e-3	
12	335.641e-3	2.55000	289.345e-3	
13	365.733e-3	2.60000	297.843e-3	
14	395.852e-3	2.65000	307.399e-3	
15	425.931e-3	2.70000	319.114e-3	
16	456.022e-3	2.75000	335.019e-3	
17	486.152e-3	2.80000	358.130e-3	
18	516.249e-3	2.85000	392.470e-3	
19	546.354e-3	2.90000	443.018e-3	
20	576.472e-3	2.95000	513.734e-3	
21	606.571e-3	3.00000	607.941e-3	
22	636.657e-3	3.05000	727.840e-3	
23	732.668e-3	3.10000	880.684e-3	
24	762.807e-3	3.15000	1.05620	
25	792.916e-3	3.20000	1.26342	
26	823.015e-3	3.25000	1.50420	
27	853.117e-3	3.30000	1.77856	
28	883.193e-3	3.35000	2.08752	
29	913.295e-3	3.40000	2.43361	
30	943.392e-3	3.45000	2.81514	
31	973.469e-3	3.50000	3.23370	
32	1.003572	3.55000	3.69118	
33	1.033664	3.60000	4.18495	
34	1.063754	3.65000	4.71651	
35	1.093893	3.70000	5.28512	
<b>Min</b>	0.000000	2.00000	208.100e-3	
<b>Max</b>	1.093893	3.70000	5.28512	
<b>Mean</b>	540.359e-3	2.85000	1.20605	
<b>StdDev</b>	336.559e-3	512.348e-3	1.44271	

To export the data as a `.csv` or `.xlsx` file, select the Export icon at the bottom of the Graph screen.

---

## Measuring I-V characteristics of a solar panel

### In this section:

Introduction.....	8-1
Equipment required .....	8-2
Set up remote communications .....	8-2
Device connections .....	8-3
Solar panel characterization .....	8-4

## Introduction

This example application demonstrates how to use the 2460 High-Current SourceMeter® Instrument to measure the I-V characteristics of a solar panel.

From the I-V characteristics measured by the 2460, you can determine important parameters about the solar panel, including:

- Maximum current ( $I_{MAX}$ ) and voltage ( $V_{MAX}$ )
- Maximum power ( $P_{MAX}$ )
- Open circuit voltage ( $V_{OC}$ )
- Short-circuit current ( $I_{SC}$ )

Because the 2460 has four-quadrant source capability, it can sink up to 7 A of cell current as a function of the applied voltage.

## Equipment required

- One 2460 High-Current SourceMeter® Instrument
- For front-panel connections, use four insulated banana cables, such as the Keithley Instruments Model 8608 High-Performance Clip Lead Set (one set included with the 2460; you will need another set)
- For rear-panel connections, use one Model 2460-KIT Screw-Terminal Connector Kit (provided with the 2460), or you can use one set of Model 2460-BAN Banana Test Leads/Adapter Cables (with appropriate connections to the device)
- One solar panel

## Set up remote communications

You can run this application from the front panel or any of the supported communication interfaces for the instrument (GPIB, USB, or ethernet).

The following figure shows the rear-panel connection locations for the remote communication interfaces. For additional information about setting up remote communications, see [Remote communications interfaces](#) (on page 3-1).

**Figure 42: 2460 remote interface connections**

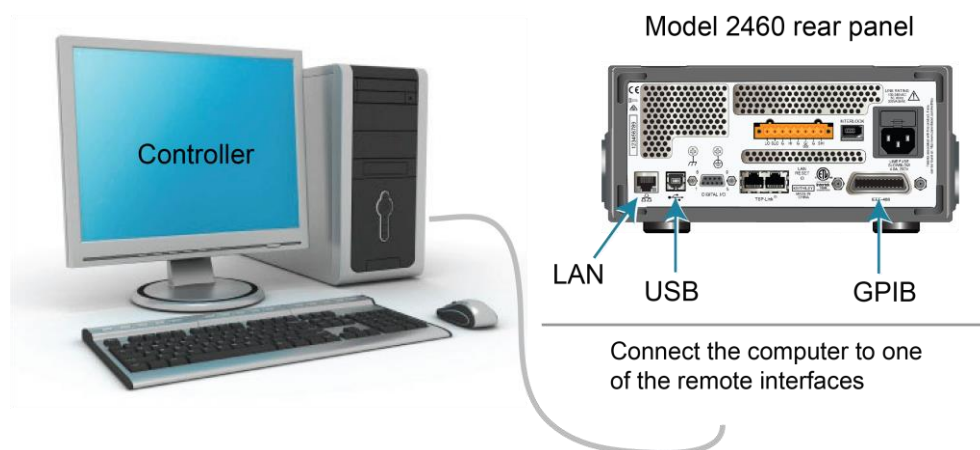

## Device connections

Connect the 2460 to the solar panel in a 4-wire configuration to provide the best measurement accuracy and eliminate the effects of the lead resistance on the measurement.

### To use the 4-wire connection method:

- Connect the FORCE LO and SENSE LO leads to the cathode terminal.
- Connect the FORCE HI and SENSE HI leads to the anode terminal.
- Make the connections as close to the solar panel as possible to avoid including the resistance of the test leads in the measurement.

You can use either the front-panel or the rear-panel terminals for this application.

### **⚠ WARNING**

**Hazardous voltages may be present on all output and guard terminals. To prevent electrical shock that could cause injury or death, never make or break connections to the 2460 while the output is on.**

**To prevent electric shock, test connections must be configured such that the user cannot come in contact with conductors or any device under test (DUT) that is in contact with the conductors. It is good practice to disconnect power before connecting DUTs. Safe installation requires proper shields, barriers, and grounding to prevent contact with conductors.**

The following figure shows the schematic for the application.

**Figure 43: Model 2460 connections to a solar panel**

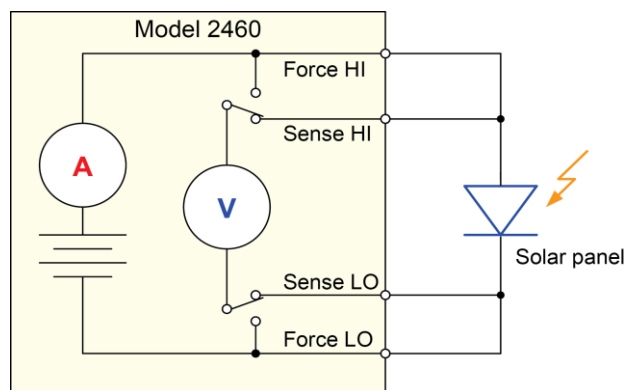

The following figures show the physical connections for the front and rear panels. Note that you must use either the front-panel terminals or rear-panel terminals — you cannot mix connections.



The figure below shows the front-panel connections. You can make these connections with four insulated banana cables that are rated to the maximum current (7 A), such as two sets of the Keithley Instruments Model 8608 High-Performance Clip Lead Set.

**Figure 44: 2460 4-wire connections to the front panel**

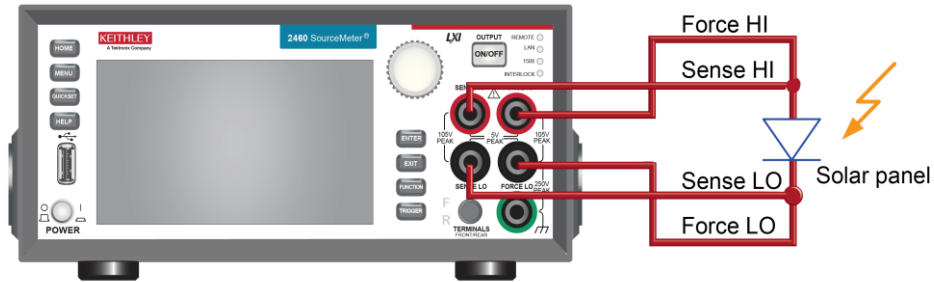

The figure below shows the rear-panel connections. You can make these connections with either the Model 2460-KIT Screw-Terminal Connector Kit (included with the 2460) or a Model 2460-BAN Banana Test Leads/Adapter Cable with appropriate cabling.

**Figure 45: 2460 4-wire connections to the rear panel**

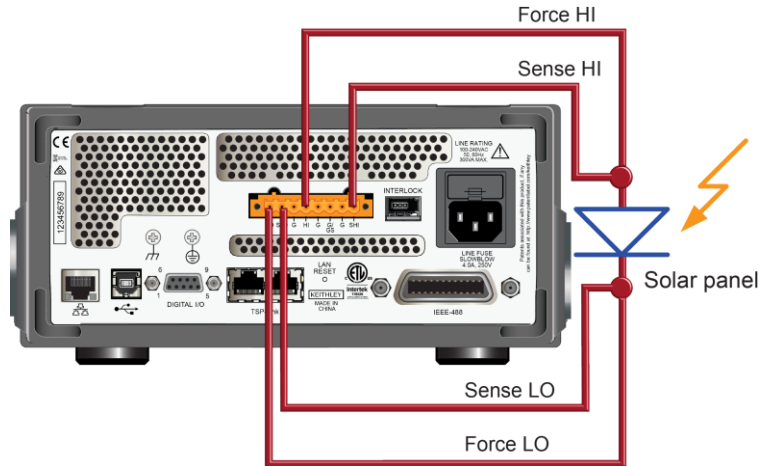

## Solar panel characterization

This application demonstrates how to use the 2460 to characterize a solar panel. The examples show how to use the front panel, SCPI code over a remote interface, and TSP code over a remote interface.

For this test, you will:

- Reset the instrument.
- Select the source voltage function and measure current function.
- Set the current limit.
- Select four-wire (remote sense) mode.
- Set up and generate a voltage sweep.
- Initiate the trigger model, which will turn the output on.
- Record the measurements.
- After the voltage sweep is complete, turn off the output.
- Retrieve the measurements.
- View the data on the front-panel graph.

---

## NOTE

You must control the light source for this application; you will run the test with the light source on and again with the light source off.

---

## Set up the solar panel I-V sweep from the front panel

This is an example of an I-V test that sweeps voltage from 0 V to 20 V in 115 steps and measures the resulting current. You can then view the data on the graph screen.

### *To set up the application from the front panel:*

1. Make connections to the instrument and device under test (DUT) as described in [Device connections](#) (on page 8-3).
2. Press the **POWER** switch on the front panel to turn on the instrument.
3. Reset the instrument:
  - a. Press the **MENU** key.
  - b. Under System, select **Info/Manage**.
  - c. Select **System Reset**.
  - d. Select **OK**.
4. Press the **HOME** key.
5. Press the **FUNCTION** key.
6. Under Source Voltage and Measure, select **Current**.

7. Press the **MENU** key.
8. Under Measure, select **Settings**.
9. Set Sense to **4-Wire Sense**.
10. Press the **MENU** key.
11. Under Source, select **Sweep**.
12. Set the Start level to **0 V** and select **OK**.
13. Set the Stop level to **20 V** and select **OK**.
14. Set Definition to **Number of Points**.
15. Set Point to **115** and select **OK**.
16. Swipe the SWEEP SETTINGS screen until you see Source Limit.
17. Set Source Limit to **4 A** and select **OK**.
18. Set Source Delay to **Specify Delay**.
19. Enter **50 ms** and select **OK**.
20. Select **Generate**. This sets up a trigger model for the sweep.
21. Press the **MENU** key.
22. Under Measure, select **Reading Buffers**.
23. Select **defbuffer1**.
24. Select **Clear** and select **Yes**.
25. Press the **MENU** key.
26. Under Views, select **Graph**.
27. Press the **TRIGGER** key to initiate the trigger model. The output turns on and a RUN indicator is visible at the top of the screen while the sweep is running.
28. Press the trigger key again to repeat the sweep.

The following figure shows an example of solar panel I-V measurements on the front-panel graph. Note that the current is negative on the graph because the 2460 is sinking current.

Figure 46: Example of solar panel measurements on the 2460 front-panel graph

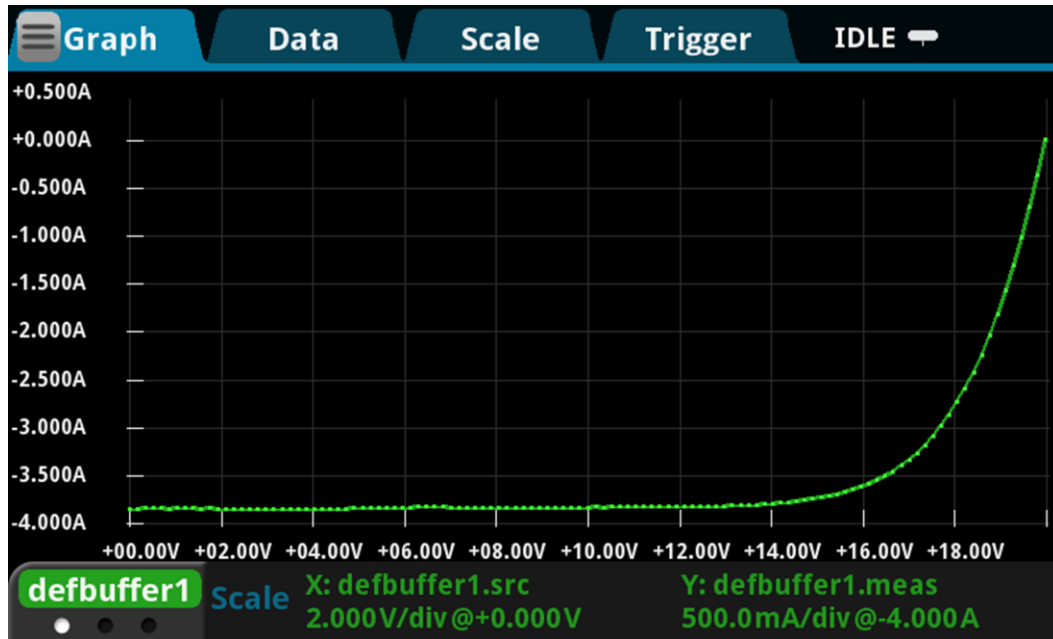

## Set up the solar panel I-V sweep using SCPI commands

This example sequence of SCPI commands generates an I-V sweep on a solar panel. You may need to make changes so that this code will run in your programming environment.

In this example, the voltage is swept from 0 V to 20 V in 115 steps. The resulting solar panel current is measured. The current and voltage measurements are stored in default buffer 1 (`defbuffer1`).

**Send the following commands for this example application:**

Command	Description
<pre>*RST SENS:FUNC "CURR" SENS:CURR:RANG:AUTO ON SENS:CURR:RSEN ON SOUR:FUNC VOLT SOUR:VOLT:RANG 20 SOUR:VOLT:ILIM 4 SOUR:SWE:VOLT:LIN 0, 20, 115, 0.05 INIT *WAI TRAC:DATA? 1, 115, "defbuffer1", SOUR, READ</pre>	<ul style="list-style-type: none"> <li>■ Reset the 2460.</li> <li>■ Set to measure current.</li> <li>■ Set to measure with autorange enabled.</li> <li>■ Set to use 4-wire sense mode.</li> <li>■ Set to source voltage.</li> <li>■ Set to the 20 V source range.</li> <li>■ Set the current limit to 4 A.</li> <li>■ Set to sweep voltage from 0 to 20 V in 115 steps with a 0.05 s delay.</li> <li>■ Initiate the sweep.</li> <li>■ Wait until the sweep is finished.</li> <li>■ Read the source and measure values from <code>defbuffer1</code>.</li> </ul>

## Set up the solar panel I-V sweep using TSP commands

The following TSP code is designed to be run from Keithley Instruments Test Script Builder (TSB). TSB is a software tool that is available from [tek.com/keithley](http://tek.com/keithley). You can install and use TSB to write code and develop scripts for TSP-enabled instruments. Information about how to use TSB is in the online help for TSB and in the “Introduction to TSP operation” section of the *Model 2460 Reference Manual*.

To use other programming environments, you may need to make changes to the example TSP code.

By default, the 2460 uses the SCPI command set. You must select the TSP command set before sending TSP commands to the instrument.

### **To enable TSP commands:**

1. Press the **MENU** key.
2. Under System, select **Settings**.
3. Set the Command Set to **TSP**.
4. At the prompt to reboot, select **Yes**.

In this example, a linear voltage sweep is configured to output voltage from 0 V to 20 V in 115 steps. The instrument measures the resulting current from the solar panel during the sweep.

**Send the following commands for this example application:**

```

-- Define the number of points in the sweep.
num = 115
-- Reset the instrument and clear the buffer.
reset()
-- Set the source and measure functions.
smu.measure.func = smu.FUNC_DC_CURRENT
smu.source.func = smu.FUNC_DC_VOLTAGE
-- Configure the measurement settings.
smu.terminals = smu.TERMINALS_FRONT
smu.measure.sense = smu.SENSE_4WIRE
smu.measure.autorange = smu.ON
smu.measure.nplc = 1
-- Configure the source settings.
smu.source.highc = smu.OFF
smu.source.range = 20
smu.source.readback = smu.ON
smu.source.ilimit.level = 4
smu.source.sweeplinear("SolarPanel", 0, 20, num, 0.05)
-- Start the trigger model and wait for it to complete.
trigger.model.initiate()
waitcomplete()
-- Define initial values.
voltage = defbuffer1.sourcevalues
current = defbuffer1
isc = current[1]
mincurr = current[1]
imax = current[1]
voc = voltage[1]
vmax = voltage[1]
pmax = voltage[1]*current[1]
-- Calculate values.
for i = 1, num do
  print(voltage[i],current[i],voltage[i]*current[i])
  if (voltage[i]*current[i] < pmax) then
    pmax = voltage[i]*current[i]
    imax = current[i]
    vmax = voltage[i]
  end
  if math.abs(current[i]) < math.abs(mincurr) then
    voc = voltage[i]
  end
end
pmax = math.abs(pmax)
imax = math.abs(imax)
print("Pmax=",pmax," ,Imax=",imax," ,Vmax=",vmax," ,Isc=",isc," ,Voc=",voc)
-- Display values on the 2460 front panel.
display.changescreen(display.SCREEN_USER_SWIPE)
display.settext(display.TEXT1, string.format("Pmax = %.4fW", pmax))
display.settext(display.TEXT2, string.format("Isc = %.4fA, Voc = %.2fV", isc, voc))

```

In the example above, the instrument is programmed to display custom text on the USER swipe screen using the `display.changescreen` and `display.settext` commands. After the test is finished, the display will indicate the maximum power ( $P_{MAX}$ ), the short circuit current ( $I_{SC}$ ), and the open circuit voltage ( $V_{OC}$ ), as shown in the figure below.

Figure 47: Solar panel I-V sweep results on the USER swipe screen

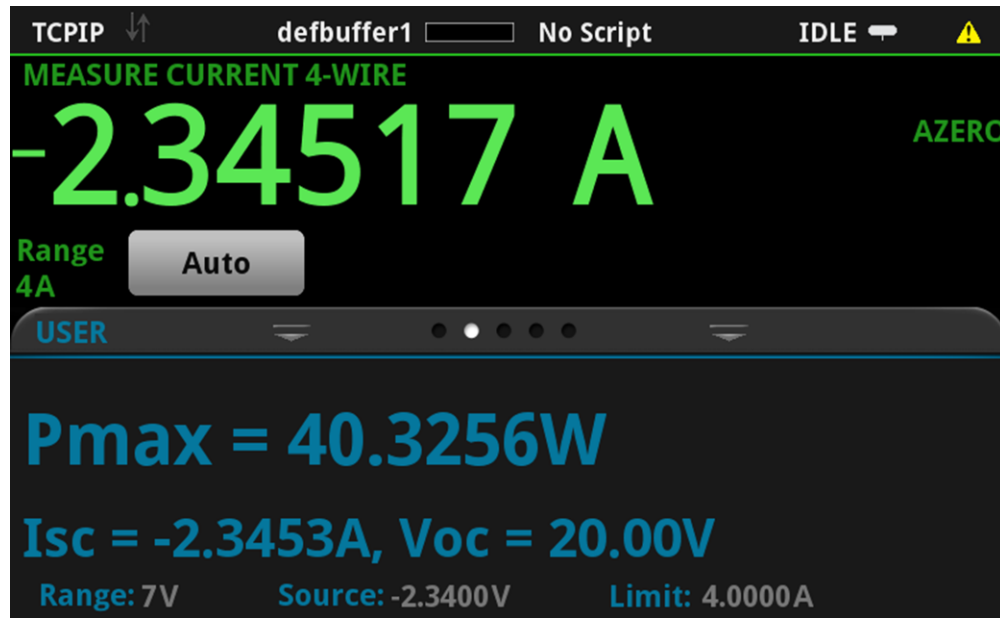

After the code is executed, five values are returned in the Instrument Console of Test Script Builder (TSB), and the measured current, voltage, and calculated power are displayed on the front panel of the 2460. You can copy the data from the TSB Instrument Console into a spreadsheet application such as Microsoft® Excel® for graphing and further analysis. The figure below shows the results of graphing the data in an Excel spreadsheet. Notice that the test on the solar panel was executed with light (light ON) and in the dark (light OFF).

**Figure 48: Solar panel I-V characteristics generated with and without light**

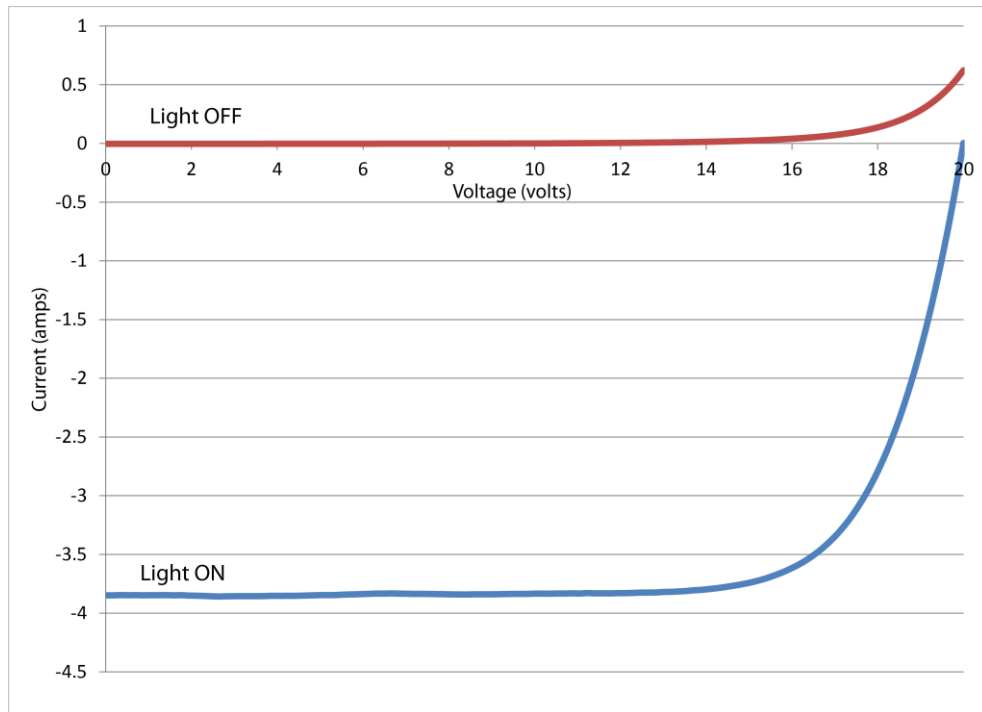



---

## Generating a high-current pulse train

### In this section:

Introduction .....	9-1
Equipment required.....	9-1
Set up remote communications.....	9-2
Device connections .....	9-2
High-speed, high-power pulses from a remote interface.....	9-4

## Introduction

This example application demonstrates how to use the 2460 High-Current SourceMeter® Instrument to generate high-current pulses (up to 7 A) and measure voltage.

Making pulsed I-V measurements may be necessary to avoid self-heating effects, device damage, or to observe the response of a device to a pulsed signal.

In this example, the trigger model controls the timing. The minimum pulse width and period may vary depending on the magnitude of the current. If you pulse low current (less than 1  $\mu$ A), you may need to use a longer pulse width to get a settled voltage measurement. We recommend that you use an oscilloscope to verify the timing accuracy when you troubleshoot your code.

## Equipment required

- One 2460 High-Current SourceMeter® Instrument
- For front-panel connections, use four insulated banana cables, such as the Keithley Instruments Model 8608 High-Performance Clip Lead Set (one set included with the 2460; you will need another set)
- For rear-panel connections, use one Model 2460-KIT Screw-Terminal Connector Kit (provided with the 2460), or you can use one set of Model 2460-BAN Banana Test Leads/Adapter Cables (with appropriate connections to the device)
- One GPIB, USB, or ethernet cable to connect the 2460 to a computer

## Set up remote communications

This application is configured to run remotely. You can run this application from any of the supported communication interfaces for the instrument (GPIB, USB, or ethernet).

The following figure shows the rear-panel connection locations for the remote communication interfaces.

**Figure 49: 2460 remote interface connections**

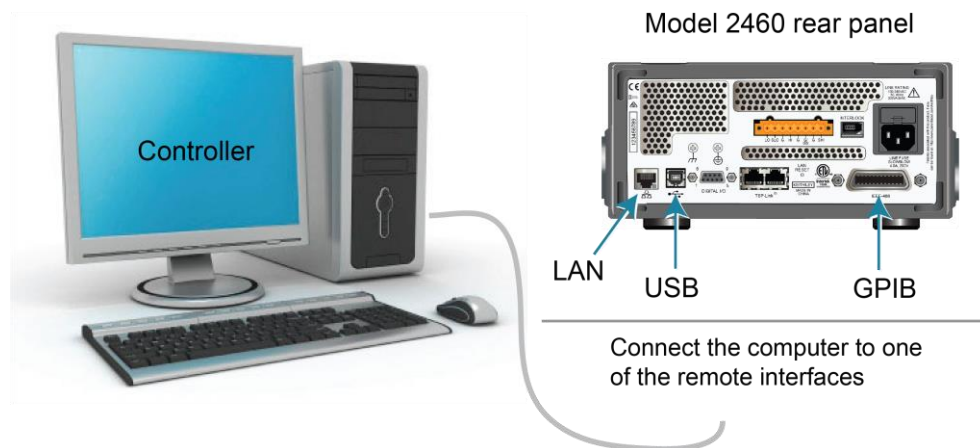

## Device connections

For best measurement accuracy and to eliminate the effects of test lead resistance when sourcing high current, connect the 2460 to the device under test (DUT) using the 4-wire sense method.

***To use the 4-wire sense connection method:***

- Connect the FORCE HI and SENSE HI leads to one end of the DUT.
- Connect the FORCE LO and SENSE LO leads to the other end of the DUT.
- Make the connections as close to the DUT as possible to exclude the test-lead resistance from the measurement.

The following figure shows the schematic for outputting high-current pulses to a resistor.

**Figure 50: Model 2460 4-wire connections to a resistor**

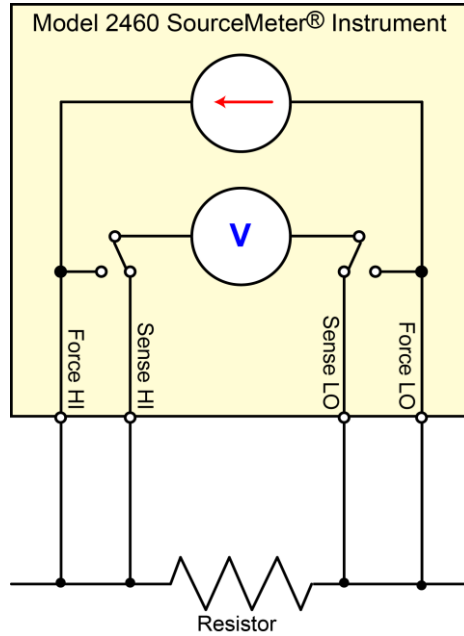

The following figures show the physical connections for the front and rear panels. The front-panel connections are safety banana jacks. The rear-panel connections are to a screw terminal.

The figure below shows the front-panel connections. You can use four insulated banana cables that are rated to a maximum current of at least 7 A, such as two sets of the Keithley Instruments Model 8608 High-Performance Clip Lead Set (one set is included with the 2460).

**Figure 51: 2460 4-wire connections to the front panel**



The figure below shows the rear-panel connections. You can make these connections with either the Model 2460-KIT Screw-Terminal Connector Kit (included with the 2460) or a Model 2460-BAN Banana Test Leads/Adapter Cable with appropriate cabling.

**Figure 52: 2460 4-wire connections to the rear panel**

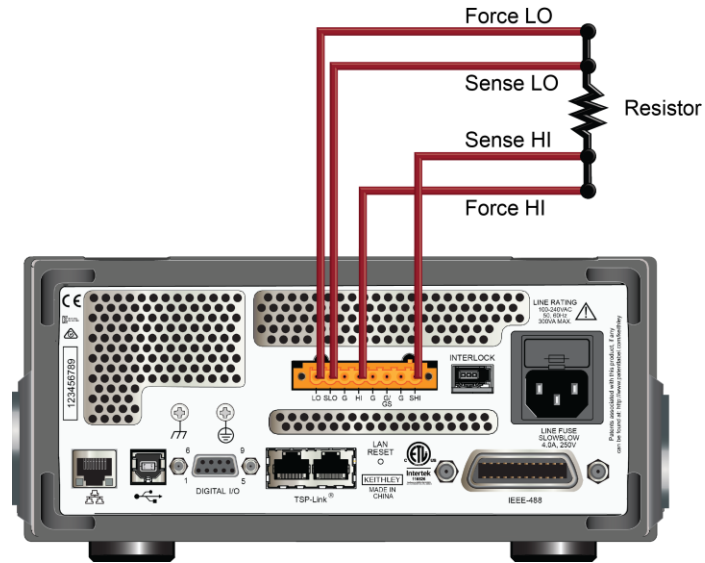

## High-speed, high-power pulses from a remote interface

In this application, the 2460 is configured from a remote interface to generate a high-power pulse sweep using Test Script Processor (TSP®) commands. A current reading is made during each pulse.

To ensure precise timing control, you will specify pulse parameters, configure the voltage source and current measurements and set up the trigger model to control the timing of the pulses and measurements.

## Define the pulse test parameters

The following pulse test parameters, which define the magnitude and timing of the pulse, are used in this example application. The actual values for these test parameters will vary depending on your specific application.

Test parameter	Value	Definition
biaslevel	0 A	Sets the offset current of the pulse train.
pulselevel	6 A	Sets the amplitude current of each pulse from zero (not from bias level).
biaswidth	3e-3 s	Sets the time at the bias level.
pulsewidth	1e-3 s	Sets the time at the amplitude level for each pulse.
period	pulsewidth + biaswidth	Specifies the amount of time it takes for the pulse to repeat itself (calculated value in this example resolves to 4 ms).
points	10	Sets the total number of pulses to generate.
limit	7 V	Sets the source limit level.
measuredelay	See Definition	$\text{pulsewidth} - ((1/\text{localnode.linefreq}) * \text{smu.measure.nplc} + 450\text{e-6})$ Specifies the amount of time that the pulse remains at the pulse level before the measurement is taken. The value 450e-6 is overhead associated with converting a raw measurement into a reading.

The following figure illustrates these test parameters.

**Figure 53: Timing diagram for the example**

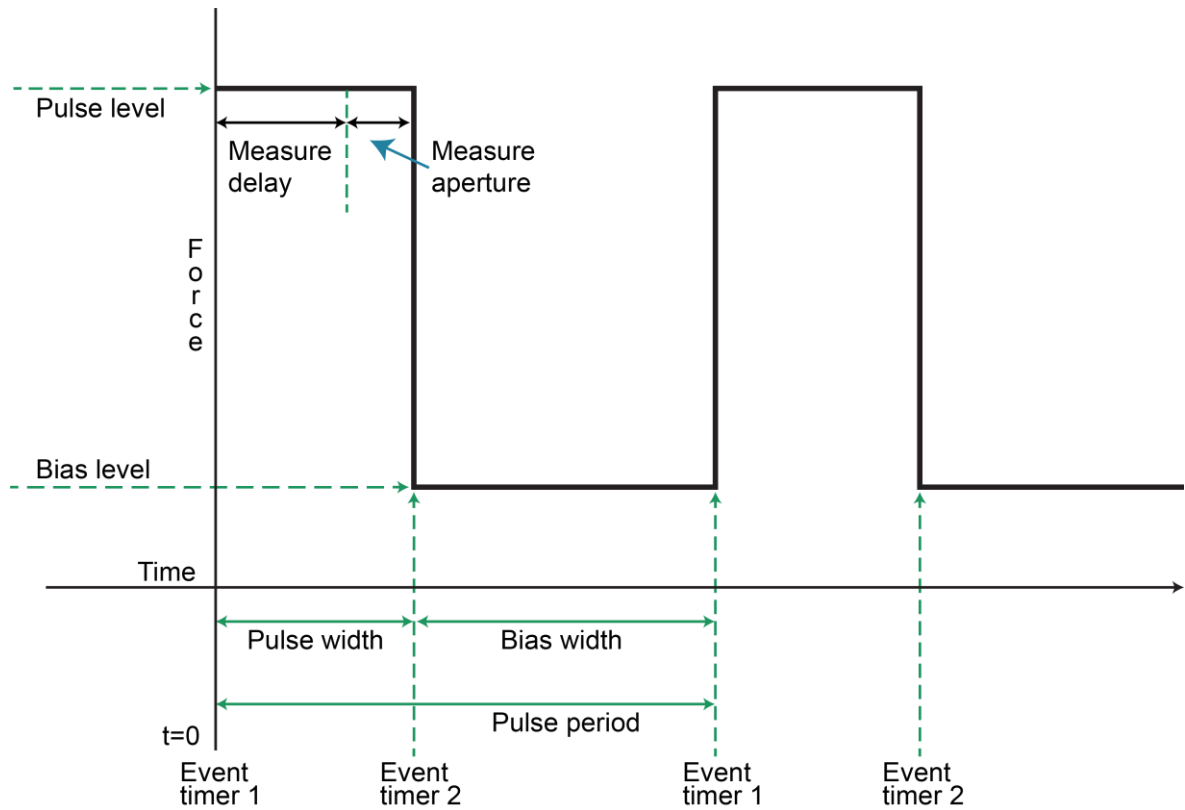

## Set up the source and measure functions

To generate high-speed, high-current pulses and measure the voltage during each pulse, it is important to configure the measure and source functions appropriately.

To minimize measure time:

- Set the voltage measure range to a fixed range.
- Set the integration rate of the measurement to 0.01 NPLC (166.67  $\mu$ s at 60 Hz line frequency).
- Run autozero once to perform a one-time autozero operation before the start of the trigger model.

For more precise source times:

- Turn off the source readback feature. If you want to use source readback, you must allow enough time for two measurements: The voltage measurement and the current source measurement.
- Set the source delay time to zero.

In this example, the two values for the source (`pulselevel` and `biaslevel`) are stored in a source configuration list named `OutputList`. This configuration list is recalled by the trigger model.

## Set up the trigger model using TSP commands

After you have set up the source and measure functions, configure the trigger model using the `trigger.model.setblock` commands. The blocks in the trigger model execute sequentially, as shown in the following figure.

Figure 54: TriggerFlow diagram used to generate a pulse train

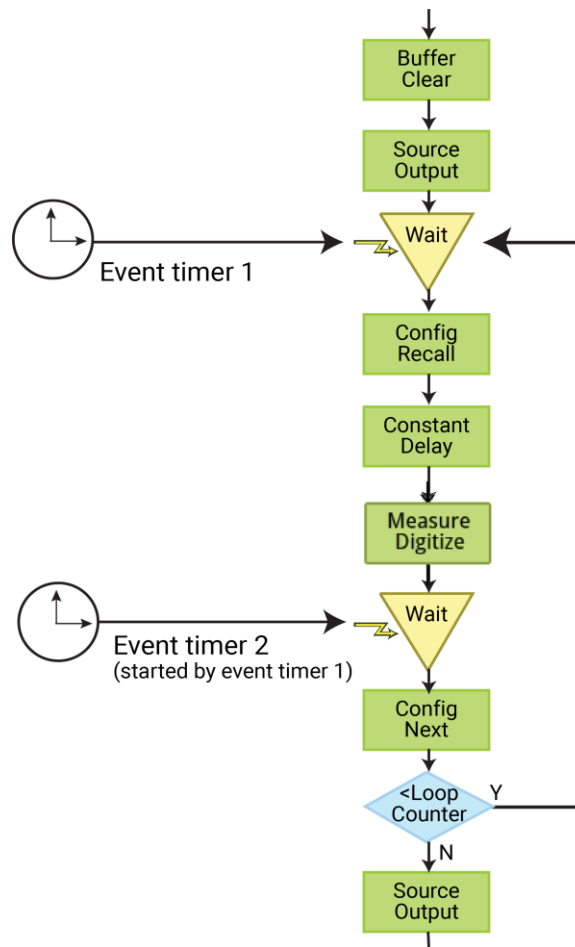

The trigger model recalls the values in the source configuration list, triggers the voltage measurement during the pulse level, and provides accurate timing of the pulse width and period using two trigger event timers (event timer 1 and event timer 2).

Event timer 1 controls the pulse period, and event timer 2 controls the pulse width. For the most precise timing, it is important that the 2460 is waiting at the Wait blocks when the timer events are generated. To guarantee that the actual pulse width matches the programmed pulse width, the Config Recall, Constant Delay, and Measure blocks must complete before the event timer 2 delay elapses.

The Constant Delay block uses the `measuredelay` value to set the time delay between when the pulse level is output and the measurement is taken. The `measuredelay` value is a calculated delay that places the measurement as close to the end of the pulse as possible.

The Branch Counter block controls how many pulses are generated based on the value of the `points` parameter.



## TSP commands to output a high-current pulse train

The following TSP code is designed to be run from Keithley Instruments Test Script Builder (TSB). TSB is a software tool that is available from [tek.com/keithley](http://tek.com/keithley). You can install and use TSB to write code and develop scripts for TSP-enabled instruments. Information about how to use TSB is in the online help for TSB and in the “Introduction to TSP operation” section of the *Model 2460 Reference Manual*.

To use other programming environments, you may need to make changes to the example TSP code.

By default, the 2460 uses the SCPI command set. You must select the TSP command set before sending TSP commands to the instrument.

### To enable TSP commands:

1. Press the **MENU** key.
2. Under System, select **Settings**.
3. Set the Command Set to **TSP**.
4. At the prompt to reboot, select **Yes**.

This following example code generates 10 pulses with a magnitude of 6 A and a pulse width of 1 ms. The pulse period is 4 ms and the load is 1  $\Omega$ . The voltage readings are stored in the default buffer, defbuffer1.

### Send the following commands for this application:

```

reset()
-- Set up the pulse parameters (user-specified).
biaslevel = 0
pulselevel = 6
biaswidth = 3e-3
pulsewidth = 1e-3
period = pulsewidth + biaswidth
points = 10
limit = 7
-- [[Set the source to output current and create a source configuration list.
]]
smu.source.configlist.create("OutputList")
smu.source.func = smu.FUNC_DC_CURRENT
smu.source.readback = smu.OFF
-- Set up the measure functions.
smu.measure.func = smu.FUNC_DC_VOLTAGE
smu.measure.nplc = 0.01
smu.terminals = smu.TERMINALS_FRONT
smu.measure.range = limit
smu.measure.sense = smu.SENSE_4WIRE
measuredelay = pulsewidth - ((1/localnode.linefreq)*smu.measure.nplc + 450e-6)
if measuredelay < 50e-6 then measuredelay = 50e-6 end
-- [[Specify a source range large enough to fit both the bias and level.
]]
smu.source.range = math.max(math.abs(biaslevel), math.abs(pulselevel))

```

```
smu.source.delay = 0
smu.source.vlimit.level = limit
-- [[Set to pulselevel (amplitude) and save the settings to the configuration list.
]]
smu.source.level = pulselevel
smu.source.configlist.store("OutputList")
-- Set to biaslevel and save settings to the configuration list.
smu.source.level = biaslevel
smu.source.configlist.store("OutputList")
-- Set up the timers.
-- [[Set timer[1] to control the period of the pulse train. The effective count will
be points because trigger.timer[1].start.generate = trigger.ON
]]
trigger.timer[1].reset()
trigger.timer[1].start.generate = trigger.ON
trigger.timer[1].delay = period
trigger.timer[1].count = points - 1
-- Set timer[2] to control the width of the pulses.
trigger.timer[2].reset()
trigger.timer[2].start.stimulus = trigger.EVENT_TIMER1
trigger.timer[2].start.generate = trigger.OFF
trigger.timer[2].delay = pulsewidth
trigger.timer[2].count = 1
trigger.timer[2].enable = trigger.ON
-- Set up the trigger model.
trigger.model.setblock(1, trigger.BLOCK_BUFFER_CLEAR)
trigger.model.setblock(2, trigger.BLOCK_SOURCE_OUTPUT, smu.ON)
trigger.model.setblock(3, trigger.BLOCK_WAIT, trigger.EVENT_TIMER1)
trigger.model.setblock(4, trigger.BLOCK_CONFIG_RECALL, "OutputList")
trigger.model.setblock(5, trigger.BLOCK_DELAY_CONSTANT, measuredelay)
trigger.model.setblock(6, trigger.BLOCK_MEASURE_DIGITIZE)
trigger.model.setblock(7, trigger.BLOCK_WAIT, trigger.EVENT_TIMER2)
trigger.model.setblock(8, trigger.BLOCK_CONFIG_NEXT, "OutputList")
trigger.model.setblock(9, trigger.BLOCK_BRANCH_COUNTER, points, 3)
trigger.model.setblock(10, trigger.BLOCK_SOURCE_OUTPUT, smu.OFF)
-- Start the trigger model.
defbuffer1.clear()
smu.measure.autozero.once()
trigger.model.initiate()
delay(0.001)
trigger.timer[1].enable = trigger.ON
waitcomplete()
```

In this example, the output is measured across the load using an oscilloscope. The following figure shows the pulse train displayed on the oscilloscope. The figure shows that the trigger model event timers generate events at uniform time intervals. This results in precise timing control.

Figure 55: Oscilloscope view of ten 1 ms, 6 A pulses into a 1 Ω load with a period of 4 ms

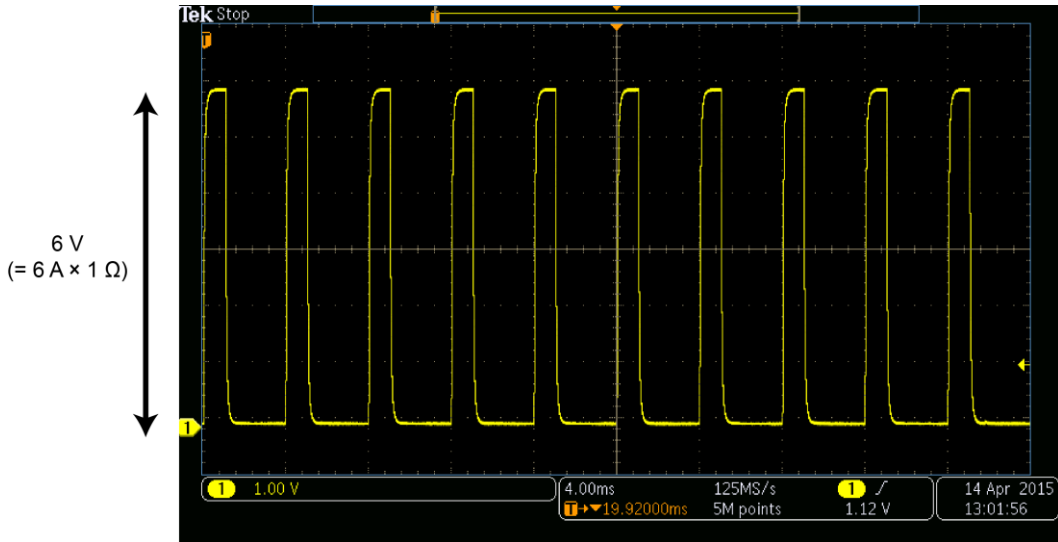

The voltage measurements made during each pulse are saved in the buffer. You can send this data to a remote interface using an appropriate `print` or `printbuffer` command, or it can be viewed from the front-panel Reading Table (press the **MENU** key and select **Reading Table**). The following figure shows a Reading Table that contains measurement values taken in this example application.

Figure 56: Reading table showing measurement results

READING TABLE			
Buffer	Active (defbuffer1)		
Index	Time	Reading	Source
1	08/07 10:02:29.889512	+5.98557V	+6.00000 A
2	08/07 10:02:29.893493	+5.98350V	+6.00000 A
3	08/07 10:02:29.897477	+5.98363V	+6.00000 A
4	08/07 10:02:29.901495	+5.98350V	+6.00000 A
5	08/07 10:02:29.905487	+5.98281V	+6.00000 A
6	08/07 10:02:29.909484	+5.98336V	+6.00000 A
7	08/07 10:02:29.913498	+5.98378V	+6.00000 A
8	08/07 10:02:29.917480	+5.98322V	+6.00000 A
9	08/07 10:02:29.921495	+5.98240V	+6.00000 A
10	08/07 10:02:29.925480	+5.98309V	+6.00000 A

Note that the timestamps in the Time column show that the readings were made precisely 4 ms apart, as configured in the trigger model.

---

## Troubleshooting FAQs

### In this section:

About this section .....	10-1
Where can I find updated drivers? .....	10-1
How do I upgrade the firmware? .....	10-2
Why can't the 2460 read my USB flash drive? .....	10-3
How do I change the command set? .....	10-3
Why am I getting a 5074 event code? .....	10-4
How do I save the present state of the instrument? .....	10-5
Why did my settings change? .....	10-5
What are the Quick Setup options? .....	10-6

## About this section

This section helps you find answers to the most common questions encountered with the 2460. For additional FAQs, see “Frequently Asked Questions (FAQs)” in the *Model 2460 Reference Manual*.

## Where can I find updated drivers?

For the latest drivers and additional support information, see the Keithley Instruments support website.

### **To see what drivers are available for your instrument:**

1. Go to [tek.com/support](http://tek.com/support).
2. Enter the model number of your instrument.
3. Select **Software** from the filter list.
4. Select **Driver** from the filter list.

---

## NOTE

If you use the native LabVIEW™ or IVI driver, you must configure the 2460 to use the SCPI command set. For information on changing the command set, refer to [How do I change the command set?](#) (on page 10-3).

---

## How do I upgrade the firmware?

---

### CAUTION

Do not turn off power or remove the USB flash drive until the upgrade process is complete.

---

### NOTE

The firmware file must be in the root subdirectory of the USB flash drive and must be the only firmware file in that location. You can upgrade or downgrade the firmware from the front panel or from the virtual front panel. Refer to “Using the 2460 virtual front panel” in the *Model 2460 Reference Manual* for information.

---

#### ***From the front panel or virtual front panel:***

1. Copy the firmware file (.upg file) to a USB flash drive.
2. Verify that the firmware file is in the root subdirectory of the flash drive and that it is the only firmware file in that location.
3. Disconnect any input and output terminals that are attached to the instrument.
4. Turn the instrument power off. Wait a few seconds.
5. Turn the instrument power on.
6. Insert the flash drive into the USB port on the front panel of the instrument.
7. From the instrument front panel, press the **MENU** key.
8. Under System, select **Info/Manage**.
9. Choose an upgrade option:
  - To upgrade to a newer version of firmware, select **Upgrade to New**.
  - To return to a previous version of firmware, select **Downgrade to Older**.
10. If the instrument is controlled remotely, a message is displayed. Select **Yes** to continue.
11. When the upgrade is complete, reboot the instrument.

A message is displayed while the upgrade is in progress.

Upgrade files are available on [tek.com/keithley](http://tek.com/keithley).

## Why can't the 2460 read my USB flash drive?

Verify that the flash drive is formatted with the FAT32 file system. The 2460 only supports FAT and FAT32 drives using Master Boot Record (MBR).

In Microsoft® Windows®, you can check the file system by checking the properties of the USB flash drive.

---

### NOTE

Higher capacity USB drives take longer to be read and loaded by the instrument.

---

## How do I change the command set?

You can change the command set that you use with the 2460. The remote command sets that are available include:

- **SCPI:** An instrument-specific language built on the SCPI standard.
- **TSP:** A scripting programming language that contains instrument-specific control commands that can be executed from a stand-alone instrument. You can use TSP to send individual commands or use it to combine commands into scripts.

If you change the command set, reboot the instrument.

You cannot combine the command sets.

---

### NOTE

As delivered from Keithley Instruments, the 2460 is set to work with the SCPI command set.

---

#### ***To set the command set from the front panel:***

1. Press the **MENU** key.
2. Under System, select **Settings**.
3. Select the appropriate **Command Set**.

You are prompted to confirm the change to the command set and reboot.

*To verify which command set is selected from a remote interface, send the command:*

```
*LANG?
```

*To change to the SCPI command set from a remote interface, send the command:*

```
*LANG SCPI
```

Reboot the instrument.

*To change to the TSP command set from a remote interface, send the command:*

```
*LANG TSP
```

Reboot the instrument.

## Why am I getting a 5074 event code?

The instrument provides an interlock circuit on the rear panel. You must enable this circuit in order for the instrument to set source voltages greater than  $\pm 42$  V DC. If you try to assign a high-voltage output and turn the source on when the interlock is not asserted, you see event code 5074, "Output voltage limited by interlock."

---

### WARNING

**The 2460 is provided with an interlock circuit that must be positively activated in order for the high voltage output to be enabled. The interlock helps facilitate safe operation of the equipment in a test system. Bypassing the interlock could expose the operator to hazardous voltages that could result in personal injury or death.**

---

The action when the interlock signal is not asserted depends on the Interlock setting. If Interlock is set to Off, if the safety interlock signal is not asserted, the following occurs:

- The nominal output is limited to less than  $\pm 42$  V.
- The front-panel INTERLOCK indicator is not illuminated.
- You can output voltages less than  $\pm 42$ .

If Interlock is set to On, when the safety interlock signal is not asserted, the following occurs:

- You cannot turn on the source output.
- The front-panel INTERLOCK indicator is not illuminated.

Whenever the interlock changes state (from asserted to not asserted or vice versa), the output is turned off.

To recover from this error, properly engage the interlock using a safe test fixture before turning on the 2460 output.

## How do I save the present state of the instrument?

You can save the settings in the instrument as a script using the front-panel menus or from a remote interface. After they are saved, you can recall the script or copy it to a USB flash drive.

### **From the front panel:**

1. Configure the 2460 to the settings that you want to save.
2. Press the **MENU** key.
3. Under Scripts, select **Create Setup**.
4. Select **Create**. A keyboard is displayed.
5. Use the keyboard to enter the name of the script.
6. Select the **OK** button on the displayed keyboard. The script is added to internal memory.

### **Using SCPI commands:**

1. Configure the instrument to the settings that you want to save.
2. Send the command:  
`*SAV <n>`  
Where <n> is an integer from 0 to 4.

---

## NOTE

In the front-panel script menus, the setups saved with the `*SAV` command have the name `Setup0x`, where `x` is the value you set for <n>.

---

### **Using TSP commands:**

1. Configure the instrument to the settings that you want to save.
2. Send the command:  
`createconfigscript("setupName")`  
Where `setupName` is the name of the setup script that is created.

## Why did my settings change?

Many of the commands in the 2460 are saved with the source or measure function that was active when you set them. For example, assume you have the measure function set to current and you set a value for display digits. When you change the measure function to voltage, the display digits value changes to the value that was last set for the voltage measure function. When you return to the current measure function, the display digits value returns to the value you set previously.



## What are the Quick Setup options?

The **QUICKSET** key opens a screen that provides access to function selection, performance adjustments, and quick setups.

The Function button on the Quickset menu allows you to select a source or measure function. The options are the same as those available when you use the front-panel **FUNCTION** key.

The Performance slider allows you to adjust speed and resolution. As you increase speed, you lower the amount of resolution. As you increase resolution, you decrease the reading speed. These settings take effect the next time the output is turned on and measurements are made.

The Quick Setups allow you to set the instrument to operate as a Voltmeter, Ammeter, Ohmmeter, or Power Supply.

---

### CAUTION

**When you select a Quick Setup, the instrument turns the output on. Carefully consider and configure the appropriate output-off state, source, and limits before connecting the 2460 to a device that can deliver energy, such as other voltage sources, batteries, capacitors, or solar cells. Configure the settings that are recommended for the instrument before making connections to the device. Failure to consider the output-off state, source, and limits may result in damage to the instrument or to the device under test (DUT).**

---

### In this section:

[Additional 2460 information.....](#) 11-1

## Additional 2460 information

This manual has prepared you to start using your new 2460 High-Current SourceMeter® Instrument for your application. For more detailed information, refer to the Keithley Instruments *Model 2460 Reference Manual*.

Also see [tek.com/keithley](http://tek.com/keithley) for support and additional information about the instrument. From the website, you can access:

- The Knowledge Center, which contains the following handbooks:
  - *The Low Level Measurements Handbook: Precision DC Current, Voltage, and Resistance Measurements*
  - *Switching Handbook: A Guide to Signal Switching in Automated Test Systems*
- Application notes
- Updated drivers
- Information about related products

Your local Field Applications Engineer can help you with product selection, configuration, and usage. Check the website for contact information.

Specifications are subject to change without notice.  
All Keithley trademarks and trade names are the property of Keithley Instruments.  
All other trademarks and trade names are the property of their respective companies.

Keithley Instruments  
Corporate Headquarters • 28775 Aurora Road • Cleveland, Ohio 44139 • 440-248-0400 • Fax: 440-248-6168 • 1-800-935-5595 • [www.keithley.com](http://www.keithley.com)

---



A Greater Measure of Confidence