

# IsoVu™ Isolated Current Probes

## TICP100, TICP050, TICP025 Datasheet

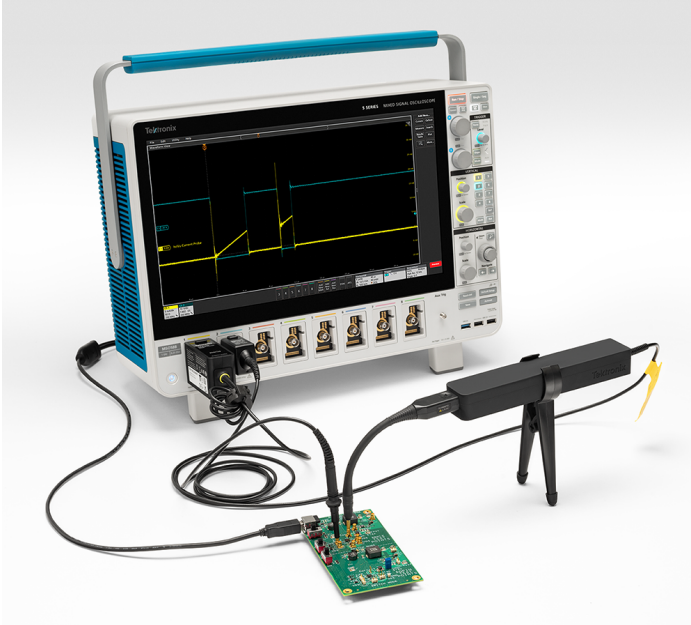

### Overview

TICP Series IsoVu™ isolated current probes deliver exceptional bandwidth, noise rejection, accuracy, and ease of use for making current measurements.

Complete galvanic isolation eliminates ground loops and enables very high common mode rejection. In a 1X configuration, the TICP Series probe's 50  $\Omega$  input offers extremely low noise of less than 4.7 nV/ $\sqrt{\text{Hz}}$ , ideal for making accurate measurements on shunts. The probes offer a variety of attenuation tips to extend the differential voltage range. Depending upon the shunt used, the probes can perform current measurements from microamperes ( $\mu\text{A}$ ) for low-power mobile designs to hundreds of amperes for industrial and mobility systems.

### Key performance specifications and features

- Galvanic isolation between probe tip and the oscilloscope
- Available in three bandwidths: 1 GHz, 500 MHz, and 250 MHz
- Wide current measurement range determined by the shunt used with 1X, 10X or 100X probe tips
- Noise <math>4.70 \text{ nV} / \sqrt{\text{Hz}}</math> (<math>21 \mu\text{V}\_{\text{RMS}}</math> at 20 MHz)
- Up to 90 dB CMRR at 1 MHz
- Maximum common mode voltage: 1.8 kV; For use in a Pollution Degree 1 environment; transient level not to exceed 5 kV<sub>pk</sub>
- 1.5% DC gain accuracy
- Compatible with the 4, 5, and 6 Series MSO instruments, including the latest B models
- TekVPI™ interface enables control and probe configuration from the oscilloscope front panel or programming interface

### Key applications

- Current shunt measurements
- Half/full bridge designs using SiC or GaN, FETs, or IGBTs
- Double pulse testing (DPT)
- Floating gate measurements
- Power converter designs
- Switching power supply designs
- Steady state, sleep, and wake-up state current monitoring

### Tips expand measurement ranges, minimize hassle, and reduce noise

TICP Series probes are well-suited for both low current and high current measurements that are challenging or impossible with sensor-based clamp-on oscilloscope probes. With three different attenuation tips, you can easily measure a wide range of currents based on the shunt resistance and its power rating.

The probes are designed to provide high-performance current measurements while offering convenient connectivity. Tips are equipped with MMCX and SMA connectors to ensure proper grounding and shielding, which is crucial for minimizing noise, ground loops, and ensuring accurate current measurements. These tips enable direct connection to most commercially available shunts, but you can also use appropriate adapters to interface the tips with their shunts.

The probe tips connect to the probe body with a unique reversible IsoConnect™ interface, allowing you to snap-fit the tips without worrying about orientation. Designed for flexibility, the probe tips have a small bend radius, facilitating connection in tight spaces. The standard probe includes a tripod adapter and a bipod for convenient placement and positioning in the test setup.

## Current shunt measurements

There are two methods to measure current in test systems. The first method involves sensing the fields around the electrical conductors and converting them into signals that represent the current. This method is used by most clamp-on style current probes, or Rogowski coils. The second method involves measuring currents using Ohm's law. One can measure current by measuring the voltage drop across a precision shunt resistor, which is the method used by the TICP Series probes.

Current shunts, or current viewing resistors (CVRs), typically have a wide frequency response, accurately measuring both AC and DC currents across a broad spectrum of frequencies. Their compact size allows for easy integration into existing circuitry with minimal space requirements. Although shunt resistors must be designed into a PCB and result in voltage drop, they offer some key advantages compared to sensor-based current measurements, including high accuracy, minimal distortion, and low interference.

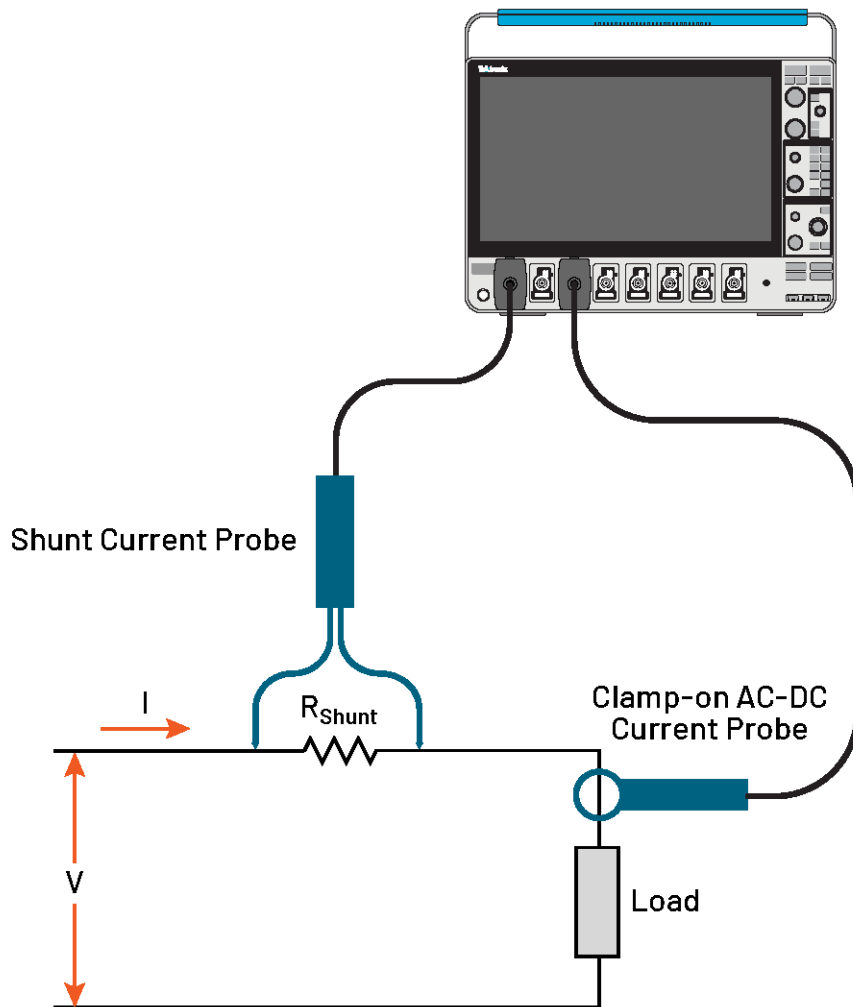

## Isolation enables floating measurements and exceptionally low noise

TICP Series IsoVu isolated current probes enable you to make more accurate dynamic current measurements on your oscilloscope, outside traditional limits.

Unlike transformer, Rogowski, or Hall effect current probes, TICP current probes enable measurements from DC to hundreds of MHz when paired with high-performance shunts or CVRs. Complete RF isolation between the probe tip and the oscilloscope eliminates ground loops and helps deliver extraordinary common mode rejection (CMRR) up to 90 dB at 1 MHz to dramatically reduce common mode noise. Low attenuation and low input impedance (50 Ω) limits noise contribution to less than 4.7 nV/√Hz noise contribution (<150 μV at 1 GHz) when measuring low voltages (± 0.5 V) across shunts.

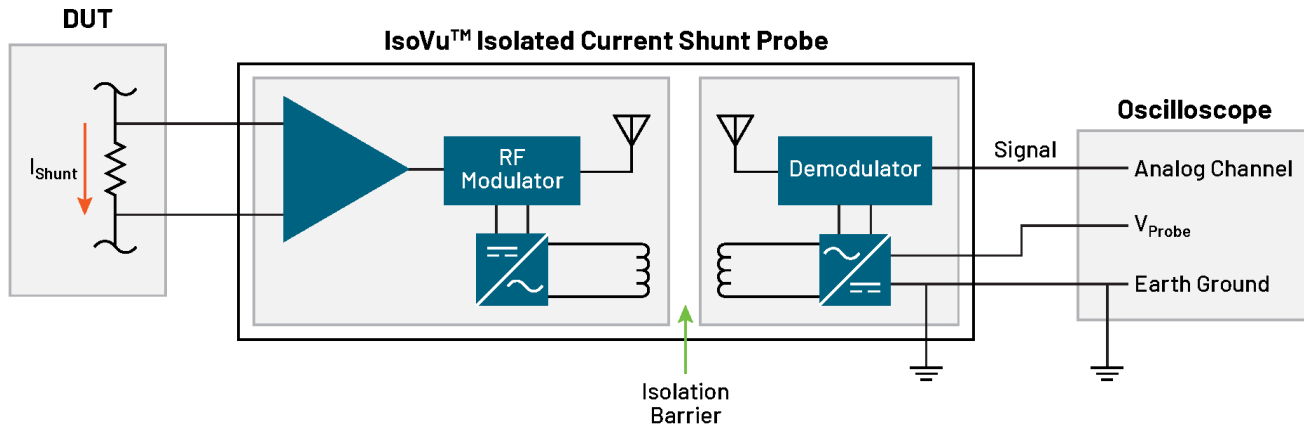

## Measuring high-fidelity currents in high power systems

TICP Series probes provide the bandwidth you need to accurately see the fast risetimes of wide bandgap (WBG) switching devices. This enables you to accurately measure dynamic currents in high-power SiC and GaN power converters. They complement the groundbreaking IsoVu™ TIVP isolated voltage probes and represent a similar isolation breakthrough for current measurements. The isolation eliminates ground loops and enables accurate measurements of high-side drain currents (I<sub>ds</sub>).

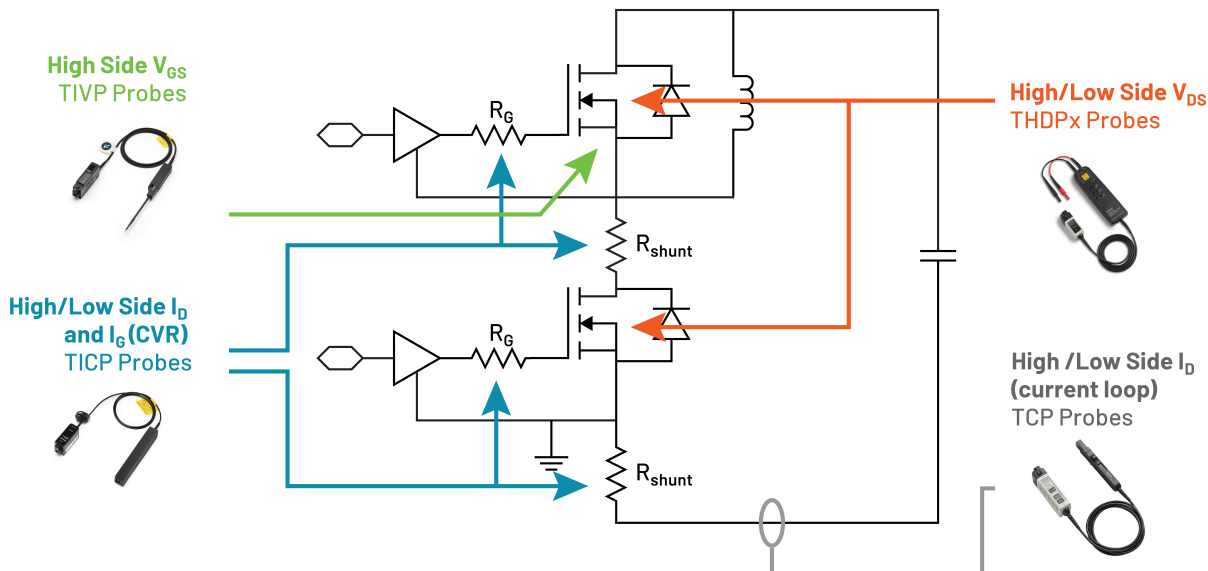

## Measuring low currents in low power systems

TICP Series probes have the bandwidth to measure current consumption during specific system activities and transitions from sleep to active states. The low-noise architecture is critical for accurately measuring low currents across the shunts. The common mode voltage rating of TICP Series is higher than most differential probes, enabling current shunt measurements on higher voltage power rails. When paired with the low-noise of the 6 Series MSO, the overall system offers low-noise performance to efficiently measure rail currents.

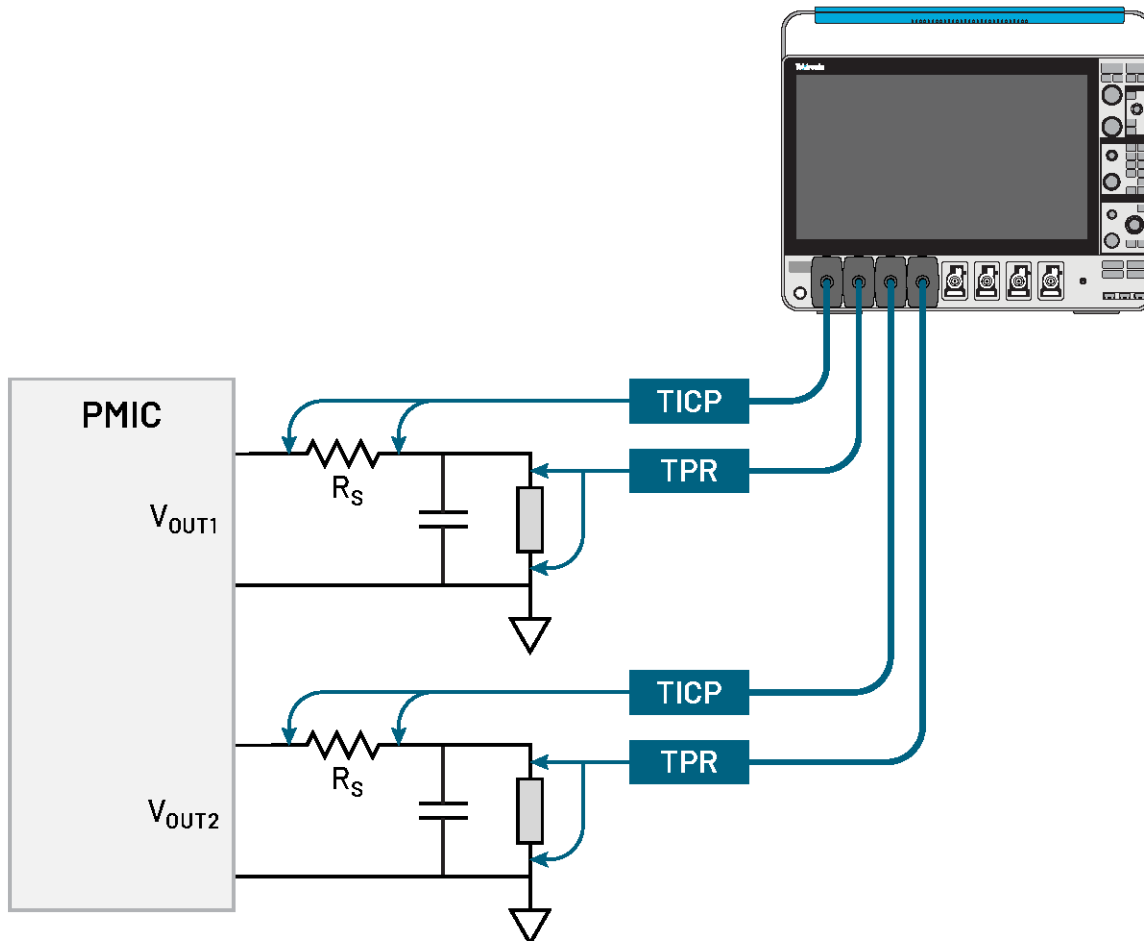

## Specifications

All specifications are typical and apply to all models unless noted otherwise.

### Probe and tip overview

Probes	TICP100	TICP050	TICP025
Bandwidth	1 GHz	500 MHz	250 MHz
Rise time	400 ps	700 ps	1.4 ns
DC gain accuracy	±1.5%		
Maximum common mode voltage	1800 V; For use in a Pollution Degree 1 environment; Max with transient level not to exceed 5kV <sub>pk</sub>		
	1300 V; Pollution degree 2; Max with transient level not to exceed 5kV <sub>pk</sub>		
	600 V for CAT III; Pollution degree 2		
	1000 V for CAT II; Pollution degree 2		
RMS noise spectral density	4.70 nV / √Hz (<21 μV <sub>RMS</sub> at 20 MHz)		
Probe cable length	2 meters (78 inches)		

### Input voltage range, input impedance

Differential input voltage range + offset range will not exceed maximum measurable input voltage. For example, offset limited to ±0.15 V in TICPSMA's ±0.5 V range. Full ±0.5 V offset available in the TICP Series probe's ±0.125 V range.

Probe tips	Differential input voltage range	Offset range	Maximum measurable input voltage (Vpk)	Maximum non-destructive differential voltage	Input impedance
TICPSMA	±0.5 V	±0.5 V	0.65 V	±3 V; 3 V <sub>RMS</sub>	50 Ω    N.A.
TICPMM1	±0.5 V	±0.5 V	0.65 V	±3 V; 3 V <sub>RMS</sub>	50 Ω    N.A.
TICPMM10	±5 V	±5 V	6.5 V	±15 V; 15 V <sub>RMS</sub>	500 Ω    <3 pF
TICPMM100	±50 V	±50 V	50 V	±60 V; 60 V <sub>RMS</sub>	5000 Ω    <3 pF

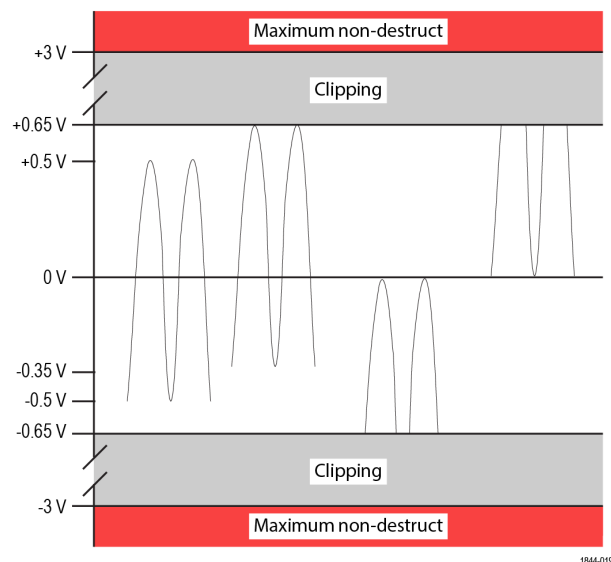

1844-019

Differential input voltage range

**Noise floor (A RMS)**

$$\text{Noise Floor (A RMS)} = \frac{4.70 \frac{\text{nV}}{\sqrt{\text{Hz}}} \times \sqrt{\text{Bandwidth}}}{R_{\text{shunt}}}$$

Shunt selection	20 MHz	250 MHz	1 GHz
50 Ω TICP as shunt	420 nA	1.5 μA	3.0 μA
5 Ω shunt	4.2 μA	14.9 μA	29.7 μA
1 Ω shunt	21 μA	74.3 μA	149 μA
500 mΩ shunt	42 μA	149 μA	297 μA
50 mΩ shunt	420 μA	1.5 mA	3.0 mA
5 mΩ shunt	4.2 mA	14.9 mA	29.7 mA
500 μΩ shunt	42 mA	149 mA	297 mA
50 μΩ shunt	420 mA	1.5 A	3.0 A
15 μΩ shunt	1.4 A	5.0 A	9.9 A

**Maximum measurable current**

Maximum depends on shunt power rating.

$$\text{Maximum Measurable Current (A)} = \frac{\text{Maximum Measurable Input } V_{pk}}{R_{\text{shunt}}}$$

Shunt selection	TICPMM1	TICPSMA	TICPMM10	TICPMM100
50 Ω TICP as shunt	13 mA		-	-
5 Ω shunt	130 mA		1.3 A	10 A
1 Ω shunt	650 mA		6.5 A	50 A
500 mΩ shunt	1.3 A		13 A	100 A
50 mΩ shunt	13 A		130 A	1.0 kA
5 mΩ shunt	130 A		1.3 kA	10 kA
500 μΩ shunt	1.3 kA		13 kA	100 kA
50 μΩ shunt	13 kA		130 kA	1000 kA
15 μΩ shunt	43.3 kA		433.3 kA	3300 kA

**Probe Ranges**

Numbers are published for TICPSMA and TICPMM1 tips. For 10X or 100X tips, multiply by 10 or 100 respectively.

Input range	Offset range	RMS noise spectral density ( $V_{RMS}$ )	Noise floor at 20 MHz ( $V_{RMS}$ )
±0.5 V	±0.15 V	22.9 nV / $\sqrt{Hz}$	102.5 $\mu V_{RMS}$
±0.35 V	±0.30 V	17.4 nV / $\sqrt{Hz}$	77.8 $\mu V_{RMS}$
±0.25 V	±0.40 V	15.0 nV / $\sqrt{Hz}$	67.2 $\mu V_{RMS}$
±0.175 V	±0.475 V	9.5 nV / $\sqrt{Hz}$	42.4 $\mu V_{RMS}$
±0.125 V	±0.5 V	8.7 nV / $\sqrt{Hz}$	38.9 $\mu V_{RMS}$
±0.09 V	±0.5 V	6.3 nV / $\sqrt{Hz}$	28.3 $\mu V_{RMS}$
±0.065 V	±0.5 V	5.5 nV / $\sqrt{Hz}$	24.7 $\mu V_{RMS}$
±0.045 V	±0.5 V	4.7 nV / $\sqrt{Hz}$	21.2 $\mu V_{RMS}$
±0.03 V	±0.5 V	4.7 nV / $\sqrt{Hz}$	21.2 $\mu V_{RMS}$
±0.02 V	±0.5 V	4.7 nV / $\sqrt{Hz}$	21.2 $\mu V_{RMS}$

**Common mode rejection ratio (CMRR)**

Probe tip	DC	1 MHz	100 MHz	250 MHz	500 MHz	1 GHz
TICPSMA	140 dB	90 dB	75 dB	50 dB	45 dB	35 dB
TICPMM1	140 dB	90 dB	80 dB	70 dB	70 dB	50 dB
TICPMM10	90 dB	70 dB	60 dB	60 dB	40 dB	20 dB
TICPMM100	75 dB	50 dB	45 dB	30 dB	20 dB	6 dB

## Application Examples

Application examples for Wide Bandgap (WBG) and PMIC power integrity.

### WBG example (800V, 40 A typical; 0.125 $\Omega$ shunt)

In a 800 V SiC circuit switching at 40 A, a 125 m $\Omega$  shunt will produce a 5 V signal. To measure this using the TICP the 10X tip must be used. In the  $\pm 3.5$  V range apply 0.3 V of offset.

The measurable current range goes from 52 A to -4 A. At these settings, the RMS noise floor at 250 MHz bandwidth is 2.2 mA RMS

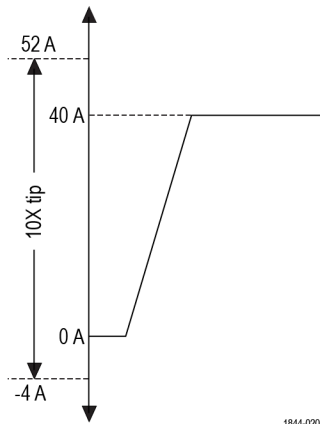

### PMIC power integrity (48 V, 3 mA typical; 1 $\Omega$ shunt)

On a 48 V PMIC bus, the standby current of 3 mA will produce a 3 mV signal on a 1  $\Omega$  shunt. Use the 1X tip in the most sensitive  $\pm 20$  mV range, apply offset to view the 3mA current and capture transients from 0 A to 40 mA with a RMS noise floor of 21.2  $\mu$ A

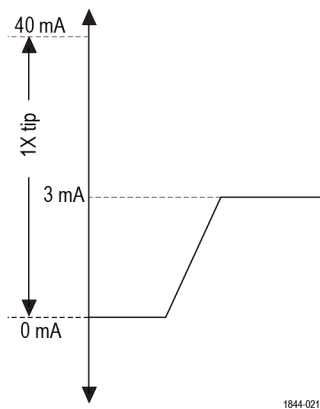

## Environmental requirements

Characteristic	Component	Operating	Non-operating
Temperature	Compensation box and probe head	0°C to +50°C	-20°C to +70°C
	Tip cables and adapters	-40°C to +85°C	-40°C to +85°C
Humidity	Compensation box and probe head	5% to 85% relative humidity up to +40°C,	5% to 85% relative humidity up to +40°C,
	Tip cables and adapters	5% to 45% relative humidity up to +50°C, non-condensing	5% to 45% relative humidity up to +70°C, non-condensing
Altitude	All components	Up to 3,000 meters (9,842 feet)	Up to 12,000 meters (39,370 feet)



## Regulatory compliance

EMC	Conforms to European Union EMC Directive (CE-marked)
Safety	Conforms to European Union Low Voltage Directive (CE-marked)
	Conforms to ANSI/UL61010-1 (CSA-marked)
	Conforms to ANSI/UL61010-2-030 (CSA-marked)
	Certified to CAN/CSA C22.2 No.61010-1 (CSA-marked)
	Certified to CAN/CSA C22.2 No.61010-2-030 (CSA-marked)
RoHS	Conforms to European Union Restrictions on Hazardous Substances (CE-marked)

## Ordering information

Select the appropriate instrument and options for your measurement needs.

### Model overview

Model	Description
<a href="#">TICP025</a>	250 MHz Tektronix Isolated Current Probe
<a href="#">TICP050</a>	500 MHz Tektronix Isolated Current Probe
<a href="#">TICP100</a>	1 GHz Tektronix Isolated Current Probe

### Standard accessories

The following table lists the accessories that are shipped with the probe.













Accessory	Description	Part number
	1X probe tip cable with MMCX connector	TICPMM1
	10X probe tip cable with MMCX connector	TICPMM10
	SMA tip adapter	TICPSMA
	Clamp-on ferrite common mode choke	276-0905-XX
	Bipod is used to hold the probe.	020-3210-XX
	Tripod adapter for 1/4 in - 20 UNC thread accessories.	103-0508-XX
	Probe tip adapter. Adapts an MMCX IsoVu tip to standard 0.100" spaced, 0.025" square pins.	131-9717-XX

Table continued...

Accessory	Description	Part number
	Soft carrying case with foam insert.	016-2147-XX

## Recommended accessories

The following table lists optional accessories.

Accessory	Description	Part number
	100X probe tip with MMCX connector	TICPMM100
	Square pin to MMCX adapter, 0.062" spacing	131-9677-XX
	MMCX to IC grabber lead	196-3546-XX
	Square pin to IC grabber lead	196-3547-XX
	MicroCKT grabbers	206-0569-XX

## Supported oscilloscopes

The measurement systems can be used with the following Tektronix oscilloscopes.

- 4 Series MSO, 4 Series B MSO
- 5 Series MSO, 5 Series B MSO, 5 Series MSO LP
- 6 Series MSO, 6 Series B MSO

## Service options

Standard warranty	1 year
Opt. R3	Repair Service 3 Years (including warranty)
Opt. R5	Repair Service 5 Years (including warranty)
Opt. C3	Calibration Service 3 Years
Opt. C5	Calibration Service 5 Years
Opt. D1	Calibration Data Report
Opt. D3	Calibration Data Report 3 Years (with Opt. C3)
Opt. D5	Calibration Data Report 5 Years (with Opt. C5)

Probes and accessories are not covered by the oscilloscope warranty and Service Offerings. Refer to the datasheet of each probe and accessory model for its unique warranty and calibration terms.



Tektronix is ISO 14001:2015 and ISO 9001:2015 certified by DEKRA.

ASEAN / Australasia (65) 6356 3900  
 Belgium 00800 2255 4835\*  
 Central East Europe and the Baltics +41 52 675 3777  
 Finland +41 52 675 3777  
 Hong Kong 400 820 5835  
 Japan 81 (120) 441 046  
 Middle East, Asia, and North Africa +41 52 675 3777  
 People's Republic of China 400 820 5835  
 Republic of Korea +82 2 565 1455  
 Spain 00800 2255 4835\*  
 Taiwan 886 (2) 2656 6688

Austria 00800 2255 4835\*  
 Brazil +55 (11) 3759 7627  
 Central Europe & Greece +41 52 675 3777  
 France 00800 2255 4835\*  
 India 000 800 650 1835  
 Luxembourg +41 52 675 3777  
 The Netherlands 00800 2255 4835\*  
 Poland +41 52 675 3777  
 Russia & CIS +7 (495) 6647564  
 Sweden 00800 2255 4835\*  
 United Kingdom & Ireland 00800 2255 4835\*

Balkans, Israel, South Africa and other ISE Countries +41 52 675 3777  
 Canada 1 800 833 9200  
 Denmark +45 80 88 1401  
 Germany 00800 2255 4835\*  
 Italy 00800 2255 4835\*  
 Mexico, Central/South America & Caribbean 52 (55) 56 04 50 90  
 Norway 800 16098  
 Portugal 80 08 12370  
 South Africa +41 52 675 3777  
 Switzerland 00800 2255 4835\*  
 USA 1 800 833 9200

\* European toll-free number. If not accessible, call: +41 52 675 3777

**For Further Information.** Tektronix maintains a comprehensive, constantly expanding collection of application notes, technical briefs and other resources to help engineers working on the cutting edge of technology. Please visit [www.tek.com](http://www.tek.com).

Copyright © Tektronix, Inc. All rights reserved. Tektronix products are covered by U.S. and foreign patents, issued and pending. Information in this publication supersedes that in all previously published material. Specification and price change privileges reserved. TEKTRONIX and TEK are registered trademarks of Tektronix, Inc. All other trade names referenced are the service marks, trademarks, or registered trademarks of their respective companies.

6 Nov 2024 51W-74063-0  
[tek.com](http://tek.com)

**Tektronix**®