

SAFETY ISOLATING TRANSFORMER

POWER : 22VA
 INPUT VOLTAGE : 230V
 FREQUENCY : 50/60Hz
 NOMINAL OUTPUT VOLTAGE : 2x12V

NON SHORT CIRCUIT PROOF TRANSFORMER
 IP00
 UL94V0
 OPERATING TEMPERATURE : -25°C to 50°C
 STORAGE TEMPERATURE : -25°C to 85°C
 INSULATION CLASS (IEC85) : B
 REQUIRED PROTECTION : 125mA FUSE ON PRIMARY

STANDARDS :
 UL506 (File E111078)
 CSA 22-2 (File E111078)
 VDE (File Ref:1398300)
 EN60950 (File Ref:1398300)
 EN61558-1 (File Ref:1398300)
 EN61558-2-6 (File Ref:1398300)
 CE

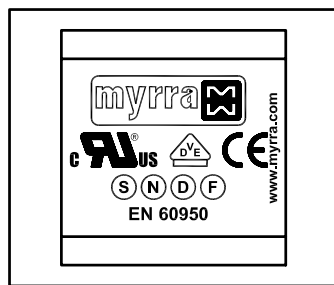
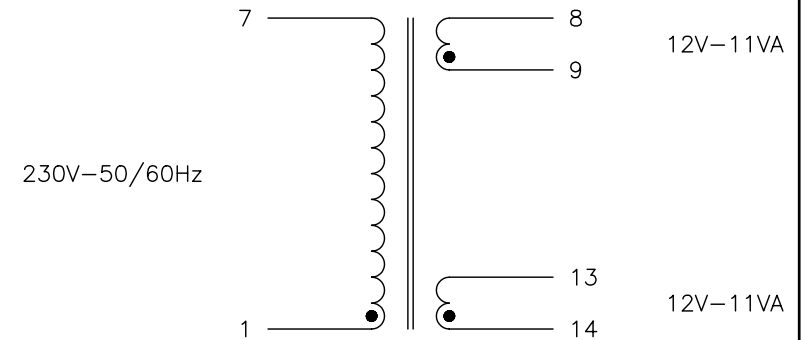
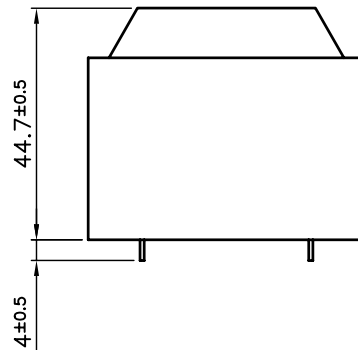
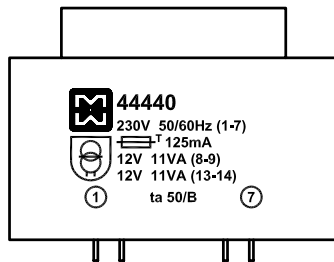

Rev	Date	Modification	Dessiné	Visa
D				
C				
B				
A				

Finition:		Tolérance générale:	
Finition:		General tolerance:	
Ech: 1:1	Matière:		
Material:			
Dessiné par: ROUSSEL.Ch	Date: 06/09/2002	Visa: J.P.M.	
DATA SHEET 44440			
EI 60x21			
		22 Allée du Clos des Charmes Z.A. Les Portes de la Forêt 77090 COLLEGIEN Tel : 01-60-37-55-55 Fax : 01-60-17-12-00	
		DS44440	