

**DRAPER**<sup>®</sup>

**STORMFORCE**

INSTRUCTIONS FOR  
**400W 230V**  
**Oscillating Multi-Tool Kit**

Stock No.16061 Part No.MT400(SF)

**IMPORTANT:** PLEASE READ THESE INSTRUCTIONS CAREFULLY TO ENSURE THE SAFE AND EFFECTIVE USE OF THIS PRODUCT.



**DRAPER**<sup>®</sup>

## GENERAL INFORMATION

These instructions accompanying the product are the original instructions. This document is part of the product, keep it for the life of the product passing it on to any subsequent holder of the product. Read all these instructions before assembling, operating or maintaining this product.

This manual has been compiled by Draper Tools describing the purpose for which the product has been designed, and contains all the necessary information to ensure its correct and safe use. By following all the general safety instructions contained in this manual, it will ensure both product and operator safety, together with longer life of the product itself.

All photographs and drawings in this manual are supplied by Draper Tools to help illustrate the operation of the product. Whilst every effort has been made to ensure the accuracy of information contained in this manual, the Draper Tools policy of continuous improvement determines the right to make modifications without prior warning.

# 1. TITLE PAGE

---

## 1.1 INTRODUCTION:

USER MANUAL FOR:

### 400W 230V OSCILLATING MULTI-TOOL KIT

Stock no. 16061

Part no. MT400(SF)

## 1.2 REVISIONS:

Date first published March 2016

\_\_\_\_\_

\_\_\_\_\_

\_\_\_\_\_

As our user manuals are continually updated, users should make sure that they use the very latest version.

Downloads are available from: <http://www.drapertools.com/manuals>

DRAPER TOOLS LIMITED

HURSLEY ROAD

CHANDLER'S FORD

EASTLEIGH

HAMPSHIRE

SO53 1YF

UK

WEBSITE: [drapertools.com](http://drapertools.com)

PRODUCT HELP LINE: +44 (0) 23 8049 4344

GENERAL FAX: +44 (0) 23 8026 0784

## 1.3 UNDERSTANDING THIS MANUALS SAFETY CONTENT:

**WARNING!** Information that draws attention to the risk of injury or death.

**CAUTION!** Information that draws attention to the risk of damage to the product or surroundings.

## 1.4 COPYRIGHT © NOTICE:

Copyright © Draper Tools Limited.

Permission is granted to reproduce this publication for personal & educational use only.

Commercial copying, redistribution, hiring or lending is prohibited.

No part of this publication may be stored in a retrieval system or transmitted in any other form or means without written permission from Draper Tools Limited.

In all cases this copyright notice must remain intact.

---

# 2. CONTENTS

---

## 2.1 CONTENTS

	<b>PAGE CONTENT</b>	<b>PAGE</b>
1	TITLE PAGE	
	1.1 INTRODUCTION .....	2
	1.2 REVISION HISTORY .....	2
	1.3 UNDERSTANDING THIS MANUAL .....	2
	1.4 COPYRIGHT NOTICE .....	2
2	CONTENTS	
	2.1 CONTENTS .....	3
3	GUARANTEE	
	3.1 GUARANTEE .....	4
4	INTRODUCTION	
	4.1 SCOPE .....	5
	4.2 SPECIFICATION .....	5
	4.3 HANDLING & STORAGE .....	5
5	HEALTH & SAFETY INFORMATION	
	5.1 GENERAL SAFETY INSTRUCTIONS FOR POWER TOOL USE .....	6
	5.2 ADDITIONAL SAFETY INSTRUCTIONS .....	7
	5.3 CONNECTION TO THE POWER SUPPLY .....	8
6	TECHNICAL DESCRIPTION	
	6.1 IDENTIFICATION .....	9
7	UNPACKING & CHECKING	
	7.1 PACKAGING .....	10
	7.2 WHAT'S IN THE BOX? .....	10
8	BASIC MULTI-TOOL OPERATIONS	
	8.1 ATTACHING THE SANDING PADS .....	11
	8.2 MOUNTING/CHANGING THE SANDING SHEET .....	11
	8.3 OPERATING THE ON/OFF SWITCH .....	11
	8.4 USING THE VARIABLE SPEED CONTROL .....	12
	8.5 SECURING THE WORKPIECE .....	12
	8.6 SANDING .....	12
	8.7 SAWING WITH THE SEGMENT SAW BLADE .....	12
	8.8 SCRAPING .....	12
9	MAINTENANCE	
	9.1 MAINTENANCE & PART REPLACEMENT .....	13
10	OPTIONAL ACCESSORIES	
	10.1 OPTIONAL ACCESSORIES .....	14-15
11	EXPLANATION OF SYMBOLS	
	11.1 EXPLANATION OF SYMBOLS .....	16
12	DISPOSAL	
	12.1 DISPOSAL .....	17
	DECLARATION OF CONFORMITY .....	ENCLOSED

## 3. GUARANTEE

---

### 3.1 GUARANTEE

Draper tools have been carefully tested and inspected before shipment and are guaranteed to be free from defective materials and workmanship.

Should the tool develop a fault, please return the complete tool to your nearest distributor or contact Draper Tools Limited, Chandler's Ford, Eastleigh, Hampshire, SO53 1YF. England.

Telephone Sales Desk: (023) 8049 4333 or Product Help Line (023) 8049 4344.

A proof of purchase must be provided with the tool.

If upon inspection it is found that the fault occurring is due to defective materials or workmanship, repairs will be carried out free of charge. This guarantee period covering parts/labour is 12 months from the date of purchase except where tools are hired out when the guarantee period is 90 days from the date of purchase. The guarantee is extended to 24 months for parts only. This guarantee does not apply to normal wear and tear, nor does it cover any damage caused by misuse, careless or unsafe handling, alterations, accidents, or repairs attempted or made by any personnel other than the authorised Draper warranty repair agent.

Note: If the tool is found not to be within the terms of warranty, repairs and carriage charges will be quoted and made accordingly.

This guarantee applies in lieu of any other guarantee expressed or implied and variations of its terms are not authorised.

Your Draper guarantee is not effective unless you can produce upon request a dated receipt or invoice to verify your proof of purchase within the guarantee period.

Please note that this guarantee is an additional benefit and does not affect your statutory rights.

Draper Tools Limited.

## 4. INTRODUCTION

---

### 4.1 SCOPE

For detail and finishing work such as sanding, cutting, scraping, etc. It is intended for domestic and light commercial use only. Any other application is considered as misuse.

### 4.2 SPECIFICATION

Stock no. ....	16061
Part no. ....	MT400(SF)
Rated voltage .....	230V~50Hz
Rated input .....	400W
Revolutions per minute (no load) .....	15,000 -22,000rpm
Sound pressure level .....	84.51dB(A)
Sound power level .....	95.51dB(A)
Vibration level .....	3.844m/s <sup>2</sup>
Weight .....	1.45kg

### 4.3 HANDLING & STORAGE

Although this machine is small in size, care must still be taken when handling and lifting. Dropping this machine will have an effect on the accuracy and may also result in personal injury. This machine is not a toy and must be respected.

The environment will have a negative result on its operation if you are not careful. If the air is damp, components will rust. If the machine is unprotected from dust and debris; components will become clogged: And if not cleaned and maintained correctly or regularly the machine will not perform at its best.

## 5. HEALTH & SAFETY INFORMATION

---

### 5.1 GENERAL SAFETY INSTRUCTIONS

General Power Tools Safety Warnings

**WARNING:** Read all instructions. Failure to follow all instructions listed below may result in electric shock, fire and/or serious injury.

Save all warnings and instructions for future reference.

The term “power tool” in the warnings refers to your mains operated (corded) power tool or battery operated (cordless) power tool.

#### 1) Work area safety

- a) **Keep work area clean and well lit.** Cluttered or dark areas invite accidents.
- b) **Do not operate power tools in explosive atmospheres, such as in the presence of flammable liquids, gases or dust.** Power tools create sparks which may ignite the dust or fumes.
- c) **Keep children and bystanders away while operating a power tool.** Distractions can cause you to lose control.

#### 2) Electrical Safety

- a) **Power tool plugs must match the outlet.** Never modify the plug in any way. Do not use any adapter plugs with earthed (grounded) power tools. Unmodified plugs and matching outlets will reduce risk of electrical shock.
- b) **Avoid body contact with earthed or grounded surfaces such as pipes, radiators, ranges and refrigerators.** There is an increased risk of electric shock if your body is earthed or grounded.
- c) **Do not expose power tools to rain or wet conditions.** Water entering a power tool will increase the risk of electric shock.
- d) **Do not abuse the cord. Never use the cord for carrying, pulling or unplugging the power tool.** Keep cord away from heat, oil, sharp edges or moving parts. Damaged or entangled cords increase the risk of electric shock.
- e) **When operating a power tool outdoors, use an extension cord suitable for outdoor use.** Use of a cord suitable for outdoor use reduces the risk of electric shock.
- f) **If operating a power tool in a damp location is unavoidable, use a residual current device (RCD) protected supply.** Use of an RCD reduces the risk of electric shock.

#### 3) Personal Safety

- a) **Stay alert, watch what you are doing and use common sense when operating a power tool. Do not use a power tool while you are tired or under the influence of drugs, alcohol or medication.** A moment of inattention while operating power tools may result in serious personal injury.
- b) **Use personal protective equipment. Always wear eye protection.** Protective equipment such as dust mask, nonskid safety shoes, hard hat, or hearing protection used for appropriate conditions will reduce personal injuries.
- c) **Prevent unintentional starting. Ensure the switch is in the off position before connecting to power source and/or battery pack, picking up or carrying the tool.** Carrying power tools with your finger on the switch or energising power tools that have the switch on invites accidents.
- d) **Remove any adjusting key or wrench before turning the power tool on.** A wrench or a key left attached to a rotating part of the power tool may result in personal injury.
- e) **Do not overreach. Keep proper footing and balance at all times.** This enables better control of the power tool in unexpected situations.
- f) **Dress properly. Do not wear loose clothing or jewellery. Keep your hair, clothing and gloves away from moving parts.** Loose clothes, jewellery or long hair can be caught in moving parts.

## 5. HEALTH & SAFETY INFORMATION

---

g) If devices are provided for the connection of dust extraction and collection facilities, ensure these are connected and properly used. Use of dust collection can reduce dust related hazards.

### 4) Power Tool Use And Care

- a) **Do not force the power tool. Use the correct power tool for your application.** The correct power tool will do the job better and safer at the rate for which it was designed.
- b) **Do not use the power tool if the switch does not turn it on and off.** Any power tool that cannot be controlled with the switch is dangerous and must be repaired.
- c) **Disconnect the plug from the power source and/or the battery pack from the power tool before making any adjustments, changing accessories, or storing power tools.** Such preventive safety measures reduce the risk of starting the power tool accidentally.
- d) **Store idle power tools out of the reach of children and do not allow persons unfamiliar with the power tool or these instructions to operate the power tool.** Power tools are dangerous in the hands of untrained users.
- e) **Maintain power tools. Check for misalignment or binding of moving parts, breakage of parts and any other condition that may affect the power tools operation. If damaged, have the power tool repaired before use.** Many accidents are caused by poorly maintained power tools.
- f) **Keep cutting tools sharp and clean.** Properly maintained cutting tools with sharp cutting edges are less likely to bind and are easier to control.
- g) **Use the power tool, accessories and tool bits etc., in accordance with these instructions, taking into account the working conditions and the work to be performed.** Use of the power tool for operations different from intended could result in a hazardous situation.

### 5) Service

- a. **Have your power tool serviced by a qualified repair person using only identical replacement parts.** This will ensure that the safety of the power tool is maintained.

## 5.2 ADDITIONAL SAFETY INSTRUCTIONS FOR MULTI-TOOL USE

### Sander Safety Warning

#### 1) Personal Safety

- a) Wear dust protection with sanders. Exposure to dust can be detrimental to health.
- b) Connect dust extraction equipment. If the tool is provided for the connection of dust extraction and collecting equipment, ensure these are connected and properly used.

### Working hints for your tool.

- If your power tool becomes too hot, especially when used at low speed, set the speed to maximum and run it with no load for 2-3minutes to cool the motor. Avoid prolonged usage at very low speeds. Always keep the blade sharp.
- Always ensure the workpiece is firmly held or clamped to prevent movement.
- Any movement of the material may effect the quality of the cutting or sanding finish.
- Start your tool before working and turn it off only after you stop working.
- Do not start sanding without having the sandpaper fitted.
- Do not allow the sandpaper to wear away, it will damage the sanding pad. The guarantee does not cover sanding pad wear and tear.
- Use coarse grit paper to sand rough surfaces, medium grit for smooth surfaces and fine grit for the finishing surfaces. If necessary, first make a test run on scrap material.

## 5. HEALTH & SAFETY INFORMATION

---

- Excessive force will reduce the working efficiency and cause motor overload. Replacing the accessory regularly will maintain optimum working efficiency.  
**Maintain tool with care**
- **NOTE: Remove plug from the socket before carrying out any adjustment, servicing or maintenance.**
- Your power tool requires no additional lubrication or maintenance. There are no user serviceable parts in your power tool. Never use water or chemical cleaners to clean your power tool. Wipe clean with a dry cloth. Always store your power tool in a dry place. Keep the motor ventilation slots clean. Keep all working controls free of dust. Occasionally you may see sparks through the ventilation slots, this is normal and will not damage your power tool.  
If the supply cord is damaged, it must be replaced by the manufacturer, its service agent or similarly qualified persons in order to avoid a hazard.
- This tool is designed for single or double handed operation (do not overload – let the tool do the work).  
Adopt a stable stance and make sure that the mains cable is prevented from coming into contact with the machine or getting caught up on other objects preventing completion of the task being done.
- Ensure that you have removed all foreign objects such as nails and screws from the work piece before commencing sanding.
- For dry sanding only (not to be used for wet sanding).
- Avoid cutting into hidden electrical wiring, pipes or the power lead to this tool. Any cutting of this type may result in electric shock, escape of water and possibly serious injury – always use a residual current device (available separately).
- Contact with a “live” wire will make exposed metal parts of the tool “live” and create an electrical shock risk to the operator.
- Only use accessories that are in good condition. Do not use if they are torn or worn.
- Do not touch any accessory whilst it is still moving.
- Do not treat the surface to be worked with solvent-containing fluids. Materials being heated by the sanding friction can cause toxic vapours to develop.
- Keep your hands away from the cutting area. Do not reach under the material being cut.

### 5.3 CONNECTION TO THE POWER SUPPLY

Make sure the power supply information on the machine’s rating plate are compatible with the power supply you intend to connect it to.

This product comes supplied with a UK standard 3 pin plug fitted. It is designed for connection to a domestic power supply rated at 230V AC.

This appliance is Class II† and is designed for connection to a power supply matching that detailed on the rating label and compatible with the plug fitted.

If an extension lead is required, use an approved and compatible lead rated for this appliance. Follow all the instruction supplied with the extension lead.

†Double insulated : This product requires no earth connection as supplementary insulation is applied to the basic insulation to protect against electric shock in the event of failure of the basic insulation.

Apart from replacing the fuse in the plug, no other electrical work is recommended on this machine.



## 6. TECHNICAL DESCRIPTION

---

### 6.1 IDENTIFICATION



- ① On/off switch.
- ② Variable speed control.
- ③ Plug & cable.
- ④ Flange.
- ⑤ Bolt.

## 7. UNPACKING & CHECKING

### 7.1 PACKAGING

Carefully remove the multi-tool from the packaging and examine it for any sign of damage that may have happened during shipping. Lay the contents out and check them against the parts shown below. If any part is damaged or missing; please contact the Draper Help Line (the telephone number appears on the Title page) and do not attempt to use the multi-tool.

The packaging material should be retained at least during the guarantee period: in case the machine needs to be returned for repair.

**Warning!** Some of the packaging materials used may be harmful to children. Do not leave any of these materials in the reach of children.

If any of the packaging is to be thrown away, make sure they are disposed of correctly; according to local regulations.

### 7.2 WHAT'S IN THE BOX?

As well as the multi-tool; there are several parts not fitted or attached to it.

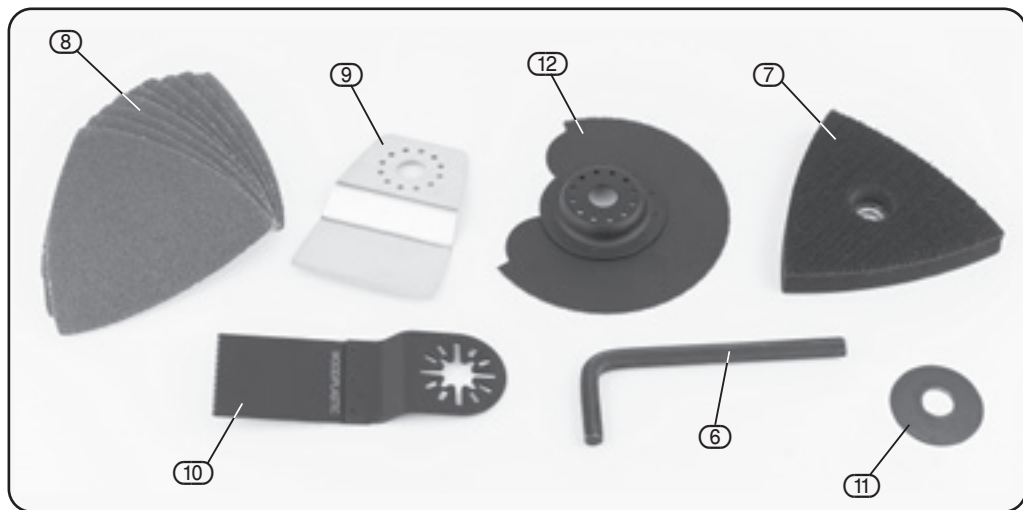

- |                                      |   |
|--------------------------------------|---|
| ⑥ Hex. Key.                          | ⑩ Offset universal blade for wood, plastic and metal. |
| ⑦ Backing pad.                       | ⑪ Washer.   |
| ⑧ Sanding sheets (80, 120, 180 GRIT) | ⑫ Semi-circle blade.                                  |
| ⑨ Offset rigid scraper blade.        |   |

## 8. BASIC MULTI-TOOL OPERATIONS

### 8.1 ATTACHING THE SANDING PADS - FIGS. 1 - 2

**CAUTION:** For all work or when changing application tools, always wear protective gloves. Avoid danger of injury from the sharp edges of the application tools. Application tools can become very hot while working, presenting danger of burns.

**WARNING:** To reduce the risk of injury, do not let the universal saw blades or any segment saw blades face back toward the user's hand.

Unscrew the bolt (5) and remove flange (4). Clean the tool holder, the application tool and the bolt (5) and flange (4).

Place the application tool exactly onto the hex-shaped tool holder. Note that the application tool has a flush fit. Reposition the flange and tighten the bolt (5) (Fig.2) using the supplied hex. key.

**NB:** Ensure bolt (5) and flange (4) are tightened firmly. Failure to do this will result in poor performance.

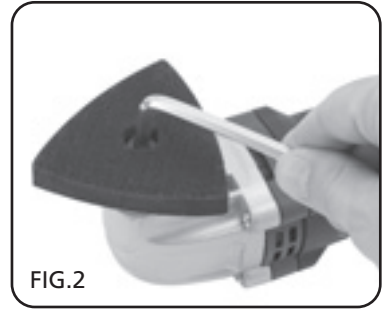
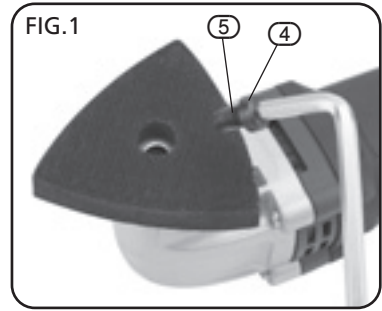

### 8.2 MOUNTING/CHANGING THE SANDING SHEET - FIG. 3

Align the sanding sheet (8) and press it onto the sanding pad (7) by hand.

Align the holes of the perforated sanding sheets with the holes of the perforated sanding pads when used.

Firmly press the power tool with the sanding sheet against a flat surface and briefly switch the power tool on. This provides for good adhesion and prevents premature wear. If one point has become worn, pull off the sanding sheet, turn it 120° and replace.

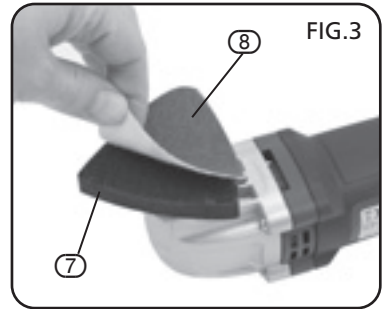

### 8.3 OPERATING THE ON/OFF SWITCH - FIG. 4

Switch the power tool ON.

Slide switch (1) forward to "I".

Switch the power tool OFF.

Slide switch (1) forward to "O".

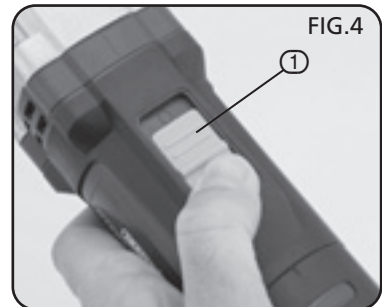

## 8. BASIC MULTI-TOOL OPERATIONS

### 8.4 USING THE VARIABLE SPEED CONTROL - FIG. 5

Select oscillation frequency (speed) while the motor is running. The variable speed control (2) can be used to set the optimum oscillating frequency according to the accessories used and the respective application.

#### **HIGH OSCILLATION FREQUENCY:**

Sanding, sawing, rasping and polishing stone and metal.

#### **LOW OSCILLATION FREQUENCY:**

Polishing varnishes.

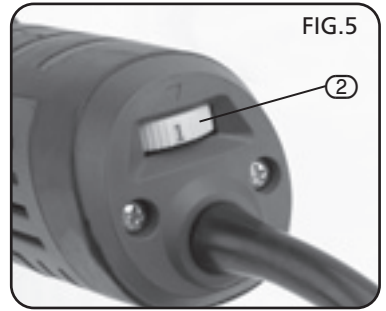

### 8.5 SECURING THE WORKPIECE

**CAUTION:** Before working with your tool make sure that no power cords will be damaged.

### 8.6 SANDING

Typical application: wood, metal; small areas, especially corners, edges and places difficult to access. Select high oscillation frequency (for variable speed models).

Sand with a constant movement and light pressure.

Heavy pressure does not increase the removal - the sanding sheet merely wears faster.

### 8.7 SAWING WITH THE SEGMENT SAW BLADE

Typical application: wood, plastics, sheet metal. Select high oscillation frequency (for variable speed models).

The saw blade lasts longer if the wear is distributed evenly. To ensure an even distribution, loosen the saw blade, rotate it and retighten firmly.

### 8.8 SCRAPING

Typical application: Scraping off old varnish or adhesives, removing glued carpeting, e.g. on stairs or other small to medium-sized surfaces.

Select medium/high oscillation frequency (for variable speed models).

## 9. MAINTENANCE

---















### **9.1 MAINTENANCE & PARTS REPLACEMENT**

Regular inspection and cleaning reduces the necessity for maintenance operations and will keep your tool in good working condition.















The motor must be correctly ventilated during tool operation. For this reason avoid blocking the air inlets. After use disconnect the tool from the power supply and vacuum the ventilation slots.

If the replacement of the supply cord is necessary, this has to be done by the manufacturer or his agent in order to avoid a safety hazard.

# 10. OPTIONAL ACCESSORIES

	Stock No.	Part No.	Description	Application
	26057	APT300A(U)	HSS segment saw blade. 63 x 0.8mm, 18TPI.	For plastic, fibreglass, wood, putty, nonferrous metals, sheet steel up to approx 1mm, idea working in corners.
	26072	APT300B(U)	HSS segment saw blade. 88 x 0.8mm, 18TPI.	For plastic, fibreglass, wood, putty, nonferrous metals, sheet steel up to approx 1mm, idea working in corners.
	26073	APT300C(U)	HSS circular saw blade. 63 x 0.8mm, 18TPI.	For plastic, fibreglass, wood, putty, nonferrous metals, sheet steel up to approx 1mm, idea working in corners.
	26074	APT300D(U)	HSS circular saw blade. 88 x 0.8mm, 18TPI.	For plastic, fibreglass, wood, putty, nonferrous metals, sheet steel up to approx 1mm, idea working in corners.
	26075	APT300E(U)	HSS circular saw blade. Heavy Duty. 85 x 1.0mm, 18TPI.	For plastic, fibreglass, wood, putty, nonferrous metals, nail, Alu, sheet steel up, idea working in corners.
	26079	APT300F(U)	HCS circular saw blade. For wood. 85 x 0.6mm, 18TPI.	For wood, drywall, plastics and other soft material, idea working in corners.
	26080	APT300G(U)	Flexible scraper blade. 51.5 x 74 x 0.5mm	For removal of silicone or acrylic caulking in plumbing work as well as stickers.
	26083	APT300H(U)	Rigid scraper blade. 51.5 x 73 x 1.0mm	For removal of stubborn paint, adhesive residue carpet, tile adhesive and undercoatings.
	26085	APT300I(U)	HCS Caulk removal knife blade. 28 x 50 x 1.0mm	For removal of silicone or acrylic caulking
	26086	APT300J(U)	Carbide rasp (triangular). 79.5 x 79.5 x 79.5 x 1.0mm	For coarse sanding, filler, tile adhesive, concrete, stone and wood. Suitable for use with without dust extraction.
	26087	APT300K(U)	Carbide rasp. 35 x 80 x 1.2mm	For coarse sanding, filler, tile adhesive, concrete, stone and wood. The finger shape, coated on both sides, is particularly suitable for artistic work.
	26088	APT300L(U)	Carbide tipped saw blade. 65 x 1.0mm	For cutting out defective tile joint and for milling cracks in plaster, porous concrete and similar building materials. Recessed flush cut capable.
	26093	APT300M(U)	Diamond coated segment saw blade. 65 x 1.0mm	For cutting out defective tile grout and cutting grooves in plaster, porous concrete and similar construction materials.
	26097	APT300N(U)	Sanding finger (thickness). 36 x 83.5 x 1.0mm (7mm)	For use in very narrow and hard-to-reach spots, in channels, grooves, openings and rabbets. Also in mound making, on convex and hollow shapes
	26098	APT300O(U)	Sanding sheet for sanding fingers. 50 x 50 x 36mm 10pc.	For use in very narrow and hard-to-reach spots, in channels, grooves, openings and rabbets. Also in mound making, on convex and hollow shapes

## 10. OPTIONAL ACCESSORIES

	Stock No.	Part No.	Description	Application
	26101	APT300P(U)	Sanding pad. 90 x 90 x 90mm.	For sander with dust extraction
	26106	APT300Q(U)	Sanding sheets for sanding pad. 90 x 90 x 90mm. 10pc.	For sander with dust extraction
	26108	APT300R(U)	HCS plunge cutter. 10 x 26.4mm. 20TPI.	For wood, drywall, plastics and other soft material.
	26110	APT300S(U)	HCS plunge cutter. 20 x 30mm. 18TPI.	For wood, drywall, plastics and other soft material.
	26114	APT300T(U)	HCS plunge cutter. 32.6 x 39mm. 18TPI.	For wood, drywall, plastics and other soft material.
	26115	APT300U(U)	HCS precision straight flush cutter. 32.6 x 39mm. 14TPI.	Highest cutting speed and precision with double row toothting. For wood, drywall, plastics and other soft material.
	26116	APT300V(U)	HCS precision cutter. 68 x 40mm. 14TPI.	Highest cutting speed and precision with double row toothting. For wood, drywall, plastics and other soft material.
	26117	APT300W(U)	Bi-metal plunger cutter. 10 x 26.4mm. 20TPI.	For wood, metal (nonferrous metal, thin ferrous sheet).
	26118	APT300X(U)	Bi-metal plunger cutter. 20 x 30mm. 18TPI.	For wood, metal (nonferrous metal, thin ferrous sheet).
	26119	APT300Y(U)	Bi-metal plunger cutter. 32.6 x 39mm. 18TPI.	For wood, metal (nonferrous metal, thin ferrous sheet).
	26124	APT300Z(U)	Bi-metal precision saw blade. 36 x 32mm. 18TPI.	For wood, metal (copper, aluminium, thin iron sheet).
	26128	APT300Z1(U)	Bi-metal wing devil saw blade. 36 x 32mm. 18TPI.	For wood, metal (copper, aluminium, thin iron sheet).
	26129	APT300Z2(U)	Bi-metal wing devil saw blade. 36 x 54mm. 18TPI.	For wood, metal (copper, aluminium, thin iron sheet).
	26130	APT300Z3(U)	HSS Segment saw blade. Width 66mm. 18TPI.	Highest cutting speed. For wood, drywall and soft plastics, flush cut capable.

# 11. EXPLANATION OF SYMBOLS

---

## 11.1 EXPLANATION OF SYMBOLS



Warning!  
Wear dust mask.



Warning!  
Read the instruction manual



Warning!  
Wear suitable eye/face  
protection.



Warning!  
Wear ear defenders.



WEEE  
Do not dispose of Waste Electrical  
& Electronic Equipment in with  
domestic rubbish



Class II construction  
(Double insulated).



# 12. DISPOSAL

---

## 12.1 DISPOSAL

- At the end of the machine's working life, or when it can no longer be repaired, ensure that it is disposed of according to national regulations.
- Contact your local authority for details of collection schemes in your area.

In all circumstances:

- Do not dispose of power tools with domestic waste.
- Do not incinerate.
- Do not abandon in the environment.
- Do not dispose of WEEE\* as unsorted municipal waste.



\* Waste Electrical & Electronic Equipment.





- **DRAPER TOOLS LIMITED,**  
Hursley Road, Chandler's Ford,  
Eastleigh, Hampshire. SO53 1YF. U.K.
- **Help Line:** (023) 8049 4344
- **Sales Desk:** (023) 8049 4333
- **General Enquiries:** (023) 8026 6355
- **Service/Warranty Repair Agent**  
For aftersales servicing or warranty repairs, please  
contact the Draper Tools Help Line for details of an  
agent in your local area.

YOUR DRAPER STOCKIST

RDCH0816

