

DRAPER[®]

STORMFORCE

INSTRUCTIONS FOR
**1/2" Square Drive
Composite Body
Air Impact Wrench & Ratchet Kit**

Stock No.83423

Part No. SFAI12/16

IMPORTANT: PLEASE READ THESE INSTRUCTIONS CAREFULLY TO ENSURE THE SAFE AND EFFECTIVE USE OF THIS PRODUCT.



CE

DRAPER[®]

GENERAL INFORMATION

These instructions accompanying the product are the original instructions. This document is part of the product, keep it for the life of the product passing it on to any subsequent holder of the product. Read all these instructions before assembling, operating or maintaining this product.

This manual has been compiled by Draper Tools describing the purpose for which the product has been designed, and contains all the necessary information to ensure its correct and safe use. By following all the general safety instructions contained in this manual, it will ensure both product and operator safety, together with longer life of the product itself.

All photographs and drawings in this manual are supplied by Draper Tools to help illustrate the operation of the product.

Whilst every effort has been made to ensure the accuracy of information contained in this manual, the Draper Tools policy of continuous improvement determines the right to make modifications without prior warning.

1. TITLE PAGE

1.1 INTRODUCTION:

USER MANUAL FOR:

COMPACT COMPOSITE AIR BODY AIR IMPACT WRENCH & RATCHET KIT

Stock no. 83423

Part no. SFAI12/16

1.2 REVISIONS:

Date first published October 2015

As our user manuals are continually updated, users should make sure that they use the very latest version.

Downloads are available from: <http://www.drapertools.com/manuals>

DRAPER TOOLS LIMITED

HURSLEY ROAD

CHANDLER'S FORD

EASTLEIGH

HAMPSHIRE

SO53 1YF

U.K.

WEBSITE: drapertools.com

PRODUCT HELPLINE: +44 (0) 23 8049 4344

GENERAL FAX: +44 (0) 23 8026 0784

1.3 UNDERSTANDING THIS MANUALS SAFETY CONTENT:

WARNING! Information that draws attention to the risk of injury or death.

CAUTION! Information that draws attention to the risk of damage to the product or surroundings.

1.4 COPYRIGHT © NOTICE:

Copyright © Draper Tools Limited.

Permission is granted to reproduce this publication for personal & educational use only. Commercial copying, redistribution, hiring or lending is prohibited.

No part of this publication may be stored in a retrieval system or transmitted in any other form or means without written permission from Draper Tools Limited.

In all cases this copyright notice must remain intact.

2. CONTENTS

2.1 CONTENTS

	PAGE CONTENT	PAGE
1	TITLE PAGE	
	1.1 INTRODUCTION	2
	1.2 REVISION HISTORY	2
	1.3 UNDERSTANDING THIS MANUAL	2
	1.4 COPYRIGHT NOTICE	2
2	CONTENTS	
	2.1 CONTENTS	3
3	GUARANTEE	
	3.1 GUARANTEE	4
4	INTRODUCTION	
	4.1 SCOPE	5
	4.2 SPECIFICATION	5
5	HEALTH & SAFETY INFORMATION	
	5.1 GENERAL SAFETY INSTRUCTIONS FOR POWER TOOL USE	6-8
	5.2 ADDITIONAL SAFETY INSTRUCTIONS FOR AIR IMPACT WRENCHES	8-9
	5.3 RESIDUAL RISK	9
6	TECHNICAL DESCRIPTION	
	6.1 IDENTIFICATION	10
7	UNPACKING & CHECKING	
	7.1 PACKAGING	11
	7.2 WHAT'S IN THE BOX	11
8	AIR SUPPLY	
	8.1 AIR TOOL OIL SPECIFICATION	12
	8.2 RECOMMENDED AIR SUPPLY SET UP	12
9	ASSEMBLY	
	9.1 CONNECTION TO THE AIR SUPPLY	13
10	OPERATION AND USE	
	IMPACT WRENCH	
	10.1 TRIGGER SWITCH	14
	10.2 FORWARD/REVERSE SPEED SELECTION	14
	10.3 ANVIL	14
	RATCHET WRENCH	
	10.4 TRIGGER SWITCH	15
	10.5 FORWARD/REVERSE SELECTION	15
	10.6 SPEED REGULATION	15
	10.7 ANVIL	15
	10.8 EXHAUST PORT	16
11	MAINTENANCE	
	11.1 EVERY-DAY MAINTENANCE CHECKS	17
	11.2 AFTER USE MAINTENANCE CHECKS	17
12	TROUBLESHOOTING	
	12.1 TROUBLESHOOTING GUIDE	18
13	DISPOSAL	
	13.1 DISPOSAL	19
14	EXPLANATION OF SYMBOLS	
	14.1 EXPLANATION OF SYMBOLS	20
	DECLARATION OF CONFORMITY	ENCLOSED

3. GUARANTEE

3.1 GUARANTEE

Draper tools have been carefully tested and inspected before shipment and are guaranteed to be free from defective materials and workmanship.

Should the tool develop a fault, please return the complete tool to your nearest distributor or contact Draper Tools Limited, Chandler's Ford, Eastleigh, Hampshire, SO53 1YF. England. Telephone Sales Desk: (023) 8049 4333 or Product Helpline (023) 8049 4344.

A proof of purchase must be provided with the tool.

If upon inspection it is found that the fault occurring is due to defective materials or workmanship, repairs will be carried out free of charge. This guarantee period covering parts/labour is 6 months from the date of purchase except where tools are hired out when the guarantee period is ninety days from the date of purchase. This guarantee does not apply to normal wear and tear, nor does it cover any damage caused by misuse, careless or unsafe handling, alterations, accidents, or repairs attempted or made by any personnel other than the authorised Draper warranty repair agent.

Note: If the tool is found not to be within the terms of warranty, repairs and carriage charges will be quoted and made accordingly.

This guarantee applies in lieu of any other guarantee expressed or implied and variations of its terms are not authorised.

Your Draper guarantee is not effective unless you can produce upon request a dated receipt or invoice to verify your proof of purchase within the guarantee period.

Please note that this guarantee is an additional benefit and does not affect your statutory rights.

Draper Tools Limited.

4. INTRODUCTION

4.1 SCOPE

This air impact wrench is designed for removal and installation of threaded fasteners. Any other use is forbidden.

4.2 SPECIFICATION

	Ratchet	Wrench
Anvil size	1/2"	1/2"
Maximum torque	90Nm/66ft-lbs.....	340Nm/250ft-lbs
Max. operating air pressure	90psi (6.3bar)	90psi (6.3bar)
Average air consumption	5.0cfm (141L/min).....	4.0cfm (113L/min)
Revolutions per minute (no load)	160min ⁻¹	7,500min ⁻¹
Minimum air line size.....	3/8" ID	3/8" ID
Air inlet.....	1/4" BSP	1/4" BSP
Sound pressure level*	94dB(A)	87dB(A)
Sound power level**	105dB(A)	98dB(A)
Vibration level	2.6m/s ²	3.3m/s ²
Weight	1.4kgs	1.8kgs

Warning: Wear approved safety glasses and ear defenders.

*Continuous A-Weighted Sound Pressure Level at the workstation in accordance to prEN ISO 15744:1999 and declared according to EN ISO 4871.

**A-Weighted Sound Power Level in accordance to prEN ISO 15744:1999 and declared according to EN ISO 4871.

5. HEALTH & SAFETY INFORMATION

5.1 GENERAL SAFETY INSTRUCTIONS FOR POWER TOOL USE

When using any type of power tool there are steps that should be taken to make sure that you, as the user, remain safe.

Common sense and a respect for the tool will help reduce the risk of injury.

Read the instruction manual fully. Do not attempt any operation until you have read and understood this manual.

Most important you must know how to safely start and stop this machine, especially in an emergency.

Keep the work area tidy and clean. Attempting to clear clutter from around the machine during use will reduce your concentration. Mess on the floor creates a trip hazard. Any liquid spilt on the floor could result in you slipping.

Find a suitable location. If the machine is bench mounted; the location should provide good natural light or artificial lighting as a replacement. Avoid damp and dust locations as it will have a negative effect on the machine's performance.

If the machine is portable; do not expose the tool to rain. In all cases do not operate power tools near any flammable materials.

Keep bystanders away. Children, onlookers and passers by must be restricted from entering the work area for their own protection. The barrier must extend a suitable distance from the tool user.

Disconnect and house all power tools that are not in use. An air tool should never be left unattended while connected to the power supply. They must be housed in a suitable location, away locked up and from children.

Do not overload or misuse the tool. All tools are designed for a purpose and are limited to what they are capable of doing. Do not attempt to use a power tool (or adapt it in any way) for an application it is not designed for. Select a tool appropriate for the size of the job. Overloading a tool will result in tool failure and user injury: This covers the use of accessories.

Dress properly. Loose clothing, long hair and jewellery are all dangerous because they can become entangled in moving machinery: This can also result in parts of body being pulled into the machine.

Clothing should be close fitted, with any long hair tied back and jewellery and neck ties removed. Footwear must be fully enclosed and have a nonslip sole.

5. HEALTH & SAFETY INFORMATION

Wear personal protective equipment (PPE). Dust, noise, vibration and swarf can all be dangerous if not suitably protected against. If the work involving the power tool creates dust or fumes; wear a dust mask. Vibration to the hand, caused by operating some tools for longer periods must be protected against. Wear vibration reducing gloves and allow long breaks between uses. Protect against dust and swarf by wearing approved safety goggles or a face shield. These are some of the more common hazards and preventions; however, always find out what hazards are associated with the machine/work process and wear the most suitable protective equipment available.

Do not breathe contaminated air. If the work creates dust or fumes; connect the machine (if possible) to an extraction system either locally or remotely. Working outdoors can also help if possible.

Move the machine as instructed. If the machine is hand held, do not carry it by the air line. If the product is heavy; employ a second or third person to help move it safely or use a mechanical device. Always refer to the instructions for the correct method.

Do not overreach. Extending your body too far can result in a loss of balance and you falling. This could be from a height or onto a machine and will result in injury.

Maintain your tools correctly. A well maintained tool will do the job safely. Replace any damaged or missing parts immediately with original parts from the manufacturer. As applicable; keep blades sharp; moving parts clean, oiled or greased; handles clean; and emergency devices working.

Wait for the machine to stop. Unless the machine is fitted with a safety brake; some parts may continue to move due to momentum. Wait for all parts to stop; then disconnect it from the air line before making any adjustments, carrying out maintenance operations or just finishing using the tool.

Remove and check setting tools. Some machinery requires the use of additional tools or keys to set, load or adjust the power tool. Before starting the power tool always check to make certain they have been removed and are safely away from the machine.

Prevent unintentional starting. Before connecting any machine in to the air supply, make sure the switch is in the OFF position. If the machine is portable; do not hold the machine near the switch and take care when putting the machine down; that nothing can operate the switch.

Concentrate and stay alert. Distractions are likely to cause an accident. Never operate a power tool if you are under the influence of drugs (prescription or otherwise), including alcohol or if you are feeling tired. Being disorientated will result in an accident.

5. HEALTH & SAFETY INFORMATION

Have this tool repaired by a qualified person. This tool is designed to conform to the relevant international and local standards and as such should be maintained and repaired by someone qualified; using only original parts supplied by the manufacturer: This will ensure the tool remains safe to use.

5.2 ADDITIONAL SAFETY INSTRUCTIONS FOR AIR IMPACT WRENCHES

Important: Draper Tools Limited recommends that this machine should not be modified or used for any application other than that for which it was designed. If you are unsure of its relative applications do not hesitate to contact us in writing and we will advise you.

- Power tools shall not be used in potentially explosive atmospheres unless specifically designed for that purpose;
- Unexpected tool movement due to reaction forces or breakage of inserted tool or reaction bar may cause injuries;
- Power tools shall be isolated from the energy source before changing or adjusting the inserted tool;
- **Warning:**
 - There is a risk of crushing by torque between a reaction bar and the workpiece;
 - There is a risk of loose clothing, hair etc., being caught in the rotating spindle of the power supply tool;
 - There is a risk of being injured if hands are not kept away from the reaction bar, specially observed when unscrewing in confined work spaces;
 - There is a risk of being injured if hands are not kept away from the nutrunner sockets;
 - There is a risk of danger to persons from high speed splinters being emitted from impact wrenches in the case of nutrunner socket failure.
 - There is a risk of being injured by whipping air hoses.
- Unexpected direction of inserted tool movement can cause a hazardous situation;
- Use only sockets and adaptors which are in good condition and are intended for use with power tools;
- Adopt a suitable posture to counteract normal or unexpected movement of the power tool due to reaction forces from the power assembly tool;
- Release the start and stop device in the case of an interruption of the energy supply;
- Only lubricants recommended by the manufacturer shall be used;
- Release pressure when not in use. Disconnect from air line;
- Impact wrenches are not torque wrenches and are not designed or capable of installing fasteners to a specified torque. For fasteners requiring a specific torque, install the fastener to well below the required value then complete the task with a hand torque wrench to avoid damaging the fastener or workpiece.
- Ensure the anvil ring is correctly maintained and if damaged or missing, is replaced immediately before work commences. Missing or damaged anvil rings may lead to sockets detaching from the wrench while rotating at high speed.
- Only use accessories specifically hardened for impact use. Do not use standard chrome type hand tool sockets as they will shatter and splinter causing injury.
- Do not modify this impact wrench in any way.
- Do not carry or move the tool by the air line.

5. HEALTH & SAFETY INFORMATION

When starting or finishing the removal and installation of fasteners there is a risk of crushing between the tool and the workpiece due to sudden movement or reaction forces.

5.3 RESIDUAL RISK

Important note:

Although the safety instructions and operating manuals for our tools contain extensive instructions of safe working with power tools, every power tool involves a certain residual risk which can not be completely excluded by safety mechanisms. Power tools must therefore always be operated with caution!

6. TECHNICAL DESCRIPTION

6.1 IDENTIFICATION



7. UNPACKING & CHECKING

7.1 PACKAGING

Carefully remove the product from the packaging and examine it for any sign of damage that may have happened during shipping. Lay the contents out and check them against the parts shown below. If any part is damaged or missing; please contact the Draper Helpline (the telephone number appears on the Title page) and do not attempt to use the product.

The packaging material should be retained at least during the guarantee period: in case the machine needs to be returned for repair.

Warning! Some of the packaging materials used may be harmful to children. Do not leave any of these materials in the reach of children.

If any of the packaging is to be thrown away, make sure they are disposed of correctly; according to local regulations.

7.2 WHAT'S IN THE BOX?

Included accessory part:

- (12) Mini inline oiler.
- (13) Oil pot.
- (14) 4mm hex. key.
- (15) Airline coupling screw adaptors.
- (16) ½" CRV sockets, sizes; 9, 10, 11, 13, 14, 17, 19, 22, 24, 27mm.

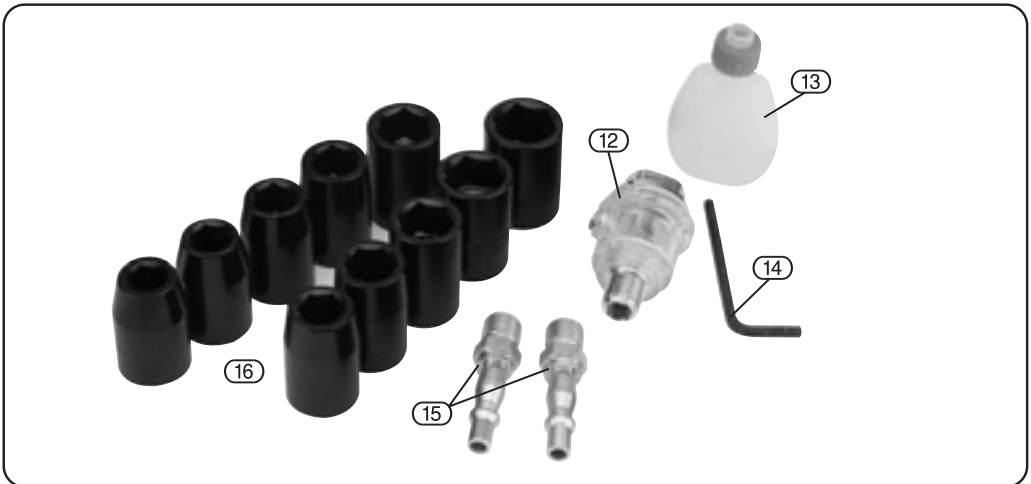

8. AIR SUPPLY

8.1 AIR TOOL OIL SPECIFICATION

Failure to follow these instructions will lead to premature malfunction of the equipment which is not covered by the guarantee.

Air tool oil viscosity refers to its properties to flow and how it reacts with heat. A low viscosity is thinner than a high viscosity.

Air tool oil becomes thinner as it heats so choosing the right viscosity is essential. If the viscosity is too low it may provide insufficient lubrication when heated. Equally, if it is too high, the fluid may provide excessive resistance to move through the lines when cold.

The ISO (International Standards Organisation) viscosity grading system measures the kinematic viscosity in centistokes (cSt) at 40° which is today's accepted standard. The SAE (Society of Automotive Engineers) viscosity grade value is based on a scale.

This equipment is suited to an ISO grade 22 – 32 (SAE grade 5W – 15W) monograde oil.

The oil must be constantly supplied to the equipment during use to ensure complete lubrication and optimum performance is achieved. It also acts as a rust inhibitor when the equipment is not in use.

We recommend the use of Draper Air Tool Oil:

250ml = Stock No.34679, 500ml = Stock No.34681, 1 Litre = Stock No.34682.

This air tool operates at a maximum pressure of 90psi and must be controlled via a combination pressure regulator, in-line lubricator and moisture filter such as the Draper range (see your local Draper stockist) which with proper maintenance will ensure a constant supply of dry air and lubricating oil at all times (see illustration below). Always check machine operating pressure before use.

Water in the compressor tank will cause serious corrosion to your air tools and should be drained daily to avoid excessive water in your air supply. Dirty wet air rapidly shortens the life of your air tool.

If you are using an air tool on a hose over 25ft long it is advisable to increase the bore of the hose to the next larger size available, i.e., 1/4" increases 3/8". This will ensure adequate pressure and volume of air to power the machine.

8.2 RECOMMENDED AIR SUPPLY SET UP – FIG. 1

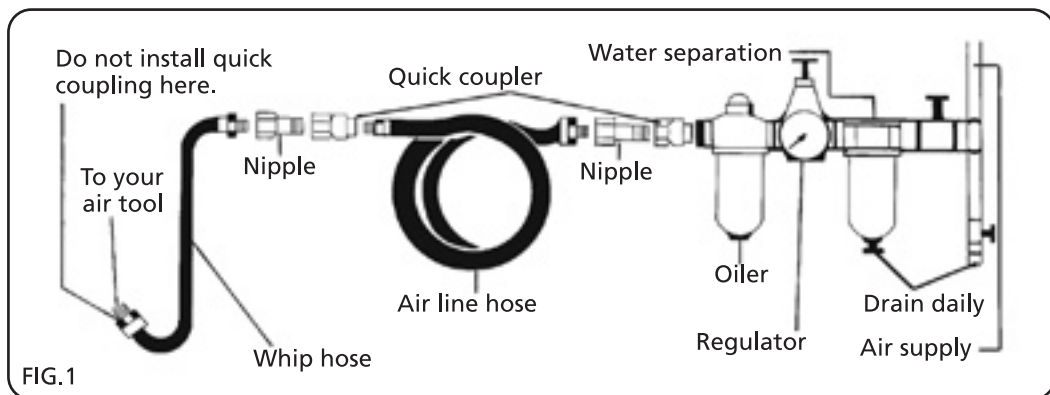

After each use and before prolonged storage, lubricate the equipment with approximately 1.5ml of air tool oil directly down the air inlet.

9. ASSEMBLY

9.1 CONNECTION TO THE AIR SUPPLY - FIGS. 1 & 2

Whip hose:

To connect the air ratchet to an air line, a ¼" BSP male thread whip hose* will be required. Wind a length of PTFE tape** around the thread before securing the hose in place. The connection must be tight for an airtight union.

* Draper Stock No.54438.

** Draper Stock No.63389.



10. OPERATION AND USE

IMPACT WRENCH

10.1 TRIGGER SWITCH - FIG. 3

Note: Before connecting the impact wrench to the air supply reduce the line pressure according to the specification.

Confirm direction of rotation prior to starting. Pull trigger ① to operate the impact wrench.

Release the trigger to stop the impact wrench. The anvil and accessory will continue to rotate briefly after the trigger has been released.

Note: Before tool operation and work commences, ensure the compressor reservoir is drained of condensation along with all connected air lines. Check and drain the air line regulator's water trap and fill up the lubrication reservoir.

10.2 FORWARD/REVERSE SPEED SELECTION - FIG. 4

The impact wrench has 3 forward speeds and two reverse speeds. Turn the combined directional speed switch ④ to engage the speed appropriate for the task in hand.

Note: Disconnect the air supply before carrying out adjustment, servicing or maintenance.

10.3 ANVIL - FIG. 5

Ensure the anvil ring ③ is correctly maintained and if damaged or missing is replaced immediately before work commences.

Ensure the socket correctly locates on the anvil firmly engaging on the anvil ring ③.

Note: It is natural for the socket to resist removal.

Warning: Only use accessories specifically hardened and designed for use with impact tools*.

Do not use standard chrome type hand tool sockets and accessories as they may shatter and splinter.

* Example: Draper 19 piece ½" impact socket set Stock No.54651

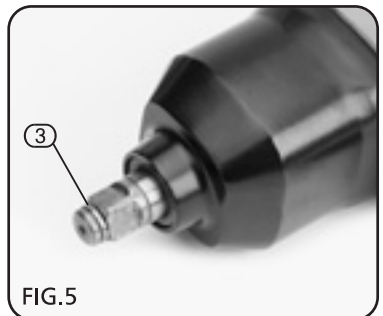
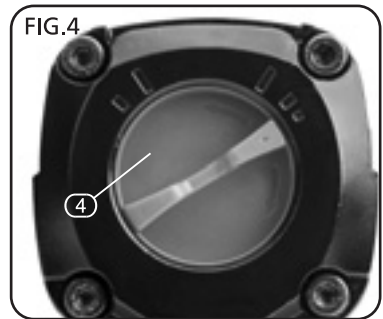
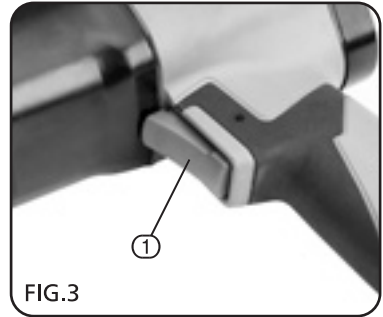

10. OPERATION AND USE

RATCHET WRENCH

10.4 TRIGGER SWITCH - FIG. 6

Note: Before connecting the air ratchet to the air supply reduce the line pressure according to the specification. Confirm direction of rotation prior to starting. Pull trigger (7) to operate the air ratchet.

Release the trigger to stop the air ratchet.

Note: Before tool operation and work commences, ensure the compressor reservoir is drained of condensate along with all connected air lines. Check and drain the air line regulator's water trap and fill up the lubrication reservoir.



10.5 FORWARD/REVERSE SELECTION - FIG. 7

Note: Air ratchets are not torque wrenches and are not designed or capable of installing fasteners to a specified torque. For fasteners requiring a specific torque, use a hand torque wrench.

Rotate the selector (10) anti-clockwise to select forward or clockwise for reverse operations.

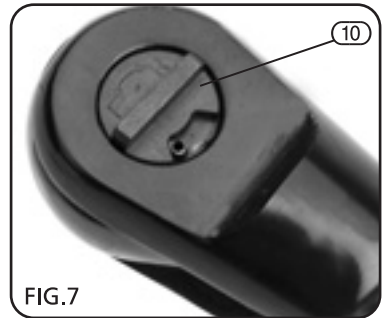

10.6 SPEED REGULATION - FIG. 8

Rotate selector (11) to regulate the speed most appropriate for the application.

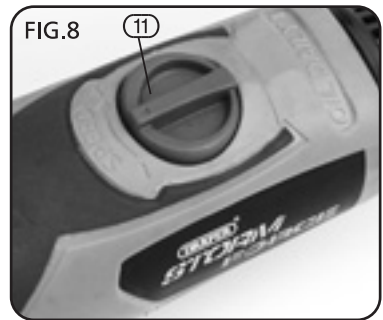

10.7 ANVIL - FIG. 9

Ensure the socket correctly locates on the anvil (8) firmly engaging on the locating ball (8.1).

Warning: Only use accessories specifically hardened and designed for use with impact tools.

Do not use standard chrome type hand tool sockets and accessories as they may shatter and splinter.

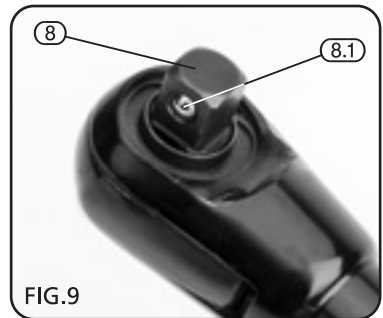

10. OPERATION AND USE

10.8 EXHAUST PORT - FIG. 10

Adjust the exhaust port (9) away from yourself and ensure it does not agitate any dust in close proximity.



11. MAINTENANCE

11.1 EVERY-DAY MAINTENANCE CHECKS

Before connection to the air supply:

- Drain the compressor reservoir of condensate.
- Drain the air lines of condensate.
- Drain the combined separator filter, regulator, water trap.
- Fill up the combined separator filter, regulator, lubricant reservoir.
- Check the line pressure is correct for the tool.

11.2 AFTER USE MAINTENANCE CHECKS

- Repeat the above procedures.
- Lubricate the tool with approximately 1.5ml of oil directly down the air inlet.

12. TROUBLESHOOTING

12.1 TROUBLESHOOTING GUIDE

Problems	Possible cause	Required action
<ul style="list-style-type: none"> • Tool runs slowly. Air flows slightly from exhaust. 	<ul style="list-style-type: none"> • Motor parts jammed with dirt particles. • Power regulator in closed position. • Air flow blocked by dirt. 	<ul style="list-style-type: none"> • Check air inlet filter for blockage. • Pour air tool lubricating oil into air inlet as per instructions. • Operate tool in short bursts, quickly reversing rotation back and forth.
<ul style="list-style-type: none"> • Motor will not run. Exhaust air flows freely. 	<ul style="list-style-type: none"> • One or more motor vanes stuck due to material build up. • Motor seized due to rust. 	<ul style="list-style-type: none"> • Pour air tool lubricating oil into air inlet. • Operate tool in short bursts of forward and/or reverse rotation (where applicable). • Tap motor housing gently with plastic mallet. • Disconnect supply, free motor by rotating drive shank manually. • If tool remains jammed, return to service centre.
<ul style="list-style-type: none"> • Sockets will not stay on. 	<ul style="list-style-type: none"> • Worn anvil ring. 	<ul style="list-style-type: none"> • Replace anvil ring.
<ul style="list-style-type: none"> • Drive shank wear. 	<ul style="list-style-type: none"> • Worn sockets or using conventional chrome plated sockets. 	<ul style="list-style-type: none"> • For any air tools, do not use chrome plated conventional sockets under any circumstances as this is a highly dangerous practice. Use only high quality impact sockets as listed in the Draper Catalogue. Chrome plated sockets can shatter and cause injury.
<ul style="list-style-type: none"> • Tool runs at normal speed but loses power under load. 	<ul style="list-style-type: none"> • Motor parts worn. • Cam clutch worn or sticking due to lack of lubricant. 	<ul style="list-style-type: none"> • Lubricant clutch housing. • Check for excess clutch oil. Clutch cases need only be half full. Overfilling can cause drag on high speed clutch parts. A typical oil, lubricated wrench only requires ½ ounce of clutch oil. <p>Grease Lubricated: Note: Heat usually indicates insufficient grease in chamber. Severe operating conditions may require more frequent lubrication.</p>
<ul style="list-style-type: none"> • Tool will not shut off. 	<ul style="list-style-type: none"> • Throttle valve 'O' ring broken or unseated. • Throttle valve stem bent or jammed with dirt particles. 	<ul style="list-style-type: none"> • Replace new 'O' rings. • Lubricate trigger with air tool lubricating oil. If trigger remains jammed return to service centre.

We recommend the use of Draper Air Tool Oil:

250ml = Stock No.34679,

500ml = Stock No.34681,

1Litre = Stock No.34682.

13. DISPOSAL

13.1 DISPOSAL

- At the end of the machine's working life, or when it can no longer be repaired, ensure that it is disposed of according to national regulations.
- Contact your local authority for details of collection schemes in your area.

In all circumstances:

- Do not dispose of power tools with domestic waste.
- Do not incinerate.
- During decommissioning of the equipment, certain hazards should be understood and avoided:
 - Only with the line pressure released shall the equipment be disassembled. Goggles should be worn.

14. EXPLANATION OF SYMBOLS



The operator's instruction must be read before work starts.



WARNING: Risk of crushing.



Direction of rotation.



Wear safety glasses.



Wear ear defenders.

- **DRAPER TOOLS LIMITED,**
Hursley Road, Chandler's Ford,
Eastleigh, Hampshire. SO53 1YF. U.K.
- **Helpline:** (023) 8049 4344
- **Sales Desk:** (023) 8049 4333
- **General Enquiries:** (023) 8026 6355
- **Service/Warranty Repair Agent**
For aftersales servicing or warranty repairs, please
contact the Draper Tools Helpline for details of an
agent in your local area.

YOUR DRAPER STOCKIST

RWMC1015

