

1. TITLE PAGE

1.1 INTRODUCTION:

USER GUIDE FOR: Engine Timing & Overhaul Kit

Stock No: 17195

Part No: ETK166

1.2 REVISIONS:

Date first published June 2018.

As our user manuals are continually updated, users should make sure that they use the very latest version.

Downloads are available from: <http://drapertools.com>

Draper Tools Limited
Hursley Road
Chandler's Ford
Eastleigh
Hampshire
SO53 1YF
UK

Website: drapertools.com

Product Helpline: +44 (0) 23 8049 4344

General Fax: +44 (0) 23 8026 0784

1.3 UNDERSTANDING THIS GUIDES SAFETY CONTENT:

WARNING! – Information that draws attention to the risk of injury or death.

CAUTION! – Information that draws attention to the risk of damage to the product or surroundings.

1.4 COPYRIGHT © NOTICE:

Copyright © Draper Tools Limited.

Permission is granted to reproduce this publication for personal and educational use only. Commercial copying, redistribution, hiring or lending is prohibited.

No part of this publication may be stored in a retrieval system or transmitted in any other form or means without written permission from Draper Tools Limited.

In all cases this copyright notice must remain intact.

2. CONTENTS

1. TITLE PAGE	
1.1 INTRODUCTION	2
1.2 REVISION HISTORY	2
1.3 UNDERSTANDING THIS GUIDE.....	2
1.4 COPYRIGHT NOTICE	2
2. CONTENTS	
2.1 CONTENTS	3
3. GUARANTEE	
3.1 GUARANTEE	4
4. GENERAL PRODUCT INFORMATION	
4.1 GENERAL PRODUCT INFORMATION	5
5. HEALTH AND SAFETY INFORMATION	
5.1 GENERAL SAFETY INSTRUCTIONS FOR USE	
Personal safety	6
6. CONTENTS	
6.1 PARTS DRAWING AND LISTING	7
7. APPLICATION	
7.1 PRODUCT APPLICATION AND COMPATIBILITY LISTING	8
8. PREPARATION	
8.1 ADVISORIES BEFORE USE	9
9. PROCEDURE AND APPLICATION GUIDE	
9.1 APPLICATION GUIDANCE	10-14
10. EXPLANATION OF SYMBOLS	
10.1 EXPLANATION OF SYMBOLS	15

3. GUARANTEE

3.1 GUARANTEE

Draper tools have been carefully tested and inspected before shipment and are guaranteed to be free from defective materials and workmanship.

Should the tool develop a fault, please return the complete tool to your nearest distributor or contact:

Draper Tools Limited, Chandler's Ford, Eastleigh, Hampshire, SO53 1YF. England.

Telephone Sales Desk: (023) 8049 4333 or:

Product Helpline (023) 8049 4344.

A proof of purchase must be provided.

If upon inspection it is found that the fault occurring is due to defective materials or workmanship, repairs will be carried out free of charge. This guarantee period covering parts/labour is 12 months from the date of purchase except where tools are hired out when the guarantee period is 90 days from the date of purchase. This guarantee does not apply to normal wear and tear, nor does it cover any damage caused by misuse, careless or unsafe handling, alterations, accidents, or repairs attempted or made by any personnel other than the authorised Draper warranty repair agent.

Note: If the tool is found not to be within the terms of warranty, repairs and carriage charges will be quoted and made accordingly.

This guarantee applies in lieu of any other guarantee expressed or implied and variations of its terms are not authorised.

Your Draper guarantee is not effective unless you can produce upon request a dated receipt or invoice to verify your proof of purchase within the guarantee period.

Please note that this guarantee is an additional benefit and does not affect your statutory rights.

Draper Tools Limited.

4. GENERAL PRODUCT INFORMATION

This product is designed to be used correctly and with care for the purpose for which it is intended. No liability is accepted by Draper Tools Limited for incorrect use or application of any of our products, and Draper Tools Limited cannot be held responsible for any damage to personnel, property or equipment when using this product. Incorrect use will also invalidate any warranty.

The applications database and any instructional information provided has been designed to offer general guidance for a particular product's use and while all attention is given to the accuracy of the data, no project should be attempted without referring first to the manufacturer's technical documentation (workshop or instruction manual) or the use of a recognised authority such as Autodata.

It is our policy to continually improve our products and thus we reserve the right to alter specifications and components without prior notice. It is the responsibility of the user to ensure the suitability of the product and information prior to use.

5. HEALTH AND SAFETY INFORMATION

GENERAL SAFETY INSTRUCTIONS

Warning: Please read all safety warnings and all details carefully. Failure to follow the warnings may result in serious injury or major component damage.

Important: Draper Tools recommends that this product should not be modified or used for any application other than that for which it was designed.

Save all warnings and instructions for future reference.

1) Personal safety

- a) Stay alert, watch what you are doing and use common sense when using this product. Do not use this product while you are tired or under the influence of drugs, alcohol or any medication. A moment of inattention while using this product may result in serious personal injury.
- b) Use personal protective equipment as necessary.
- c) Check and remove any part of the product before turning/testing the engine. A part left attached to a rotating part of the engine may result in personal injury or major component damage.
- d) Carefully clean the tool components after every use.
- f) Keep the tool components safe and tidy.
- g) Do not use this product for any purpose other than for which it is designed.

Warning! Some of the packaging materials used may be harmful to children. Do not leave any of these materials in the reach of children.

If any of the packaging is to be thrown away, make sure it is disposed of correctly; according to local regulations.

6. CONTENTS

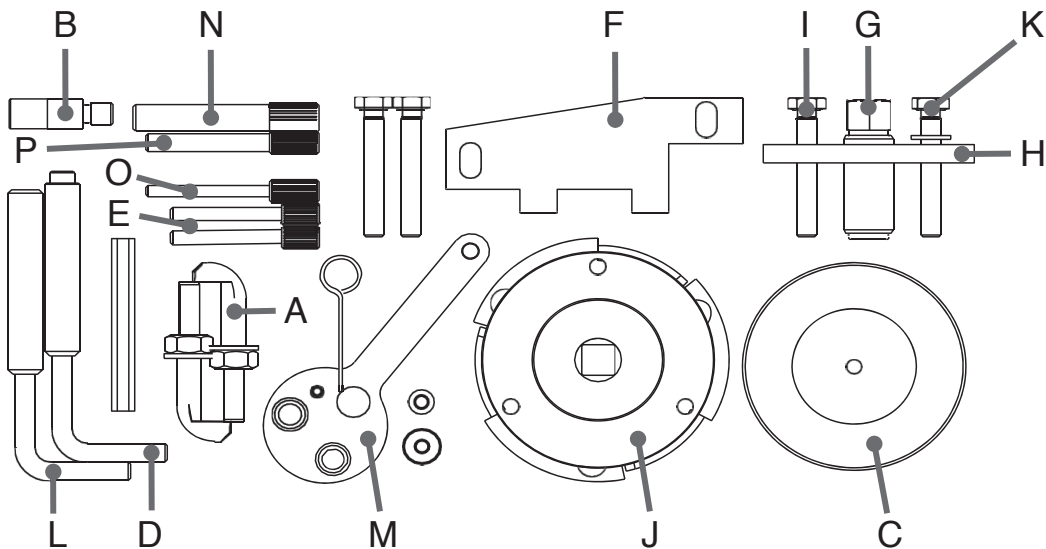

ITEM	DESCRIPTION	OEM	STOCK No.
A	Fuel Pump Remover Legs	303-249	26814
B	Centre Locating Plug For Diesel Pump Remover	303-249	26828
C	Ford Engine Front Cover Alignment Tool	303-682	27329
D	Timing Pin	303-698	27390
E	Locking Pin	N/A	27603
F	Ford Oil Pump Alignment Tool	303-705/.0198.11	27605
G	Puller Centre Screw	303-249	27679
H	Puller Beam	303-249	27743
I	Hex-Head Bolt	N/A	27841
J	Fuel Pump Cover Tool Body	303-679	27855
K	Washers	N/A	27897
L	Flywheel Locking Tool	21-234/21-251	27899
M	Crankshaft Setting Tool	303-1587	27923
N	Locking Pin	303-734	27991
O	Locking Pin	N/A	27997
P	Locking Pin	303-735	28034

7. APPLICATION

The **17195** has been developed as an **engine timing and overhaul kit** for the vehicles listed below. Allows the user to lock the timing and enables complete overhaul of diesel engines. The kit comes with oil pump alignment tool, crankshaft alignment tool, crank seal removal and insertion tool and front cover boss.

Used on the following Vehicles:

Ford C-MAX 2007 - 2010
Ford Fiesta 2002 - 2011 TDCi
Ford Focus 2004 - 2011
Ford Focus C-MAX 2003 - 2007
Ford Fusion 2002 - 2011 TDCi EConetic
Ford Ranger 2011 - 2017
Ford Ranger 2011 - 2017
Ford Tourneo Connect 2015 - 2017 TDCi HDT
Ford Tourneo Courier 2015 - 2017 TDCi Sport
Ford Tourneo Cus-m 2012 - 2016
Ford Transit 2006 - 2017
Ford Transit Connect 2015 - 2017 TD4
Ford Transit Courier 2015 - 2017
Ford Transit Cus-m 2012 - 2017
Land Rover Defender 2006 - 2016

Engine Codes:

1.4cc
F6JA, F6JB, F6JC, F6JD
1.5cc
XUGA, XVGA, XVGB, XVGC, XWGA, XWGB, XUcc, , XUCD, XVCA, XVCB, XVcc
1.6cc
G8DA, G8DB, G8DC, G8DD, G8DE, G8DF, GPDA, GPDC, HHDA, HHDB, MTD, HHJA, HHJB, HHJC, HHJD, HHJE, HHJF, GPDB
2.2cc
GBVAJ (QW2R), GBVAJPF, GBVAJQJ, CYFB, DRFA, DRFB, P8FA, QVFA, QWFA, SRFA, SRFB, GBVAJQW, CVFF, CYFF, DRFF, CYFA, P8FB, PGFA, PGFB, SRFC, SRFD, SRFE, UHFA, UHFB, CYFC, DRFC, CVF5, CVR5, CYF5, CYFG, CYR5, DRF5, DRR5, UHR5, DRFG, USR6, UYR6, ID4/DT224
2.4cc
244DT
3.2cc
SAFA

8. PREPARATION

The following is for guidance only. Please refer to OEM derived data such as the vehicle manufacturer's own data or Autodata. The use of this product is purely down to the user's discretion and Draper Tools Limited cannot be held responsible for any damage caused what so ever.

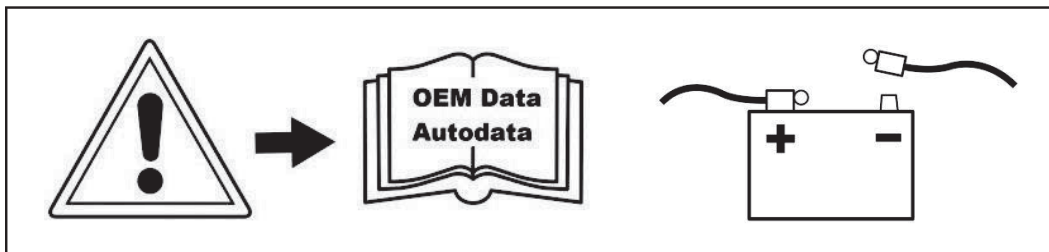

9. PROCEDURE AND APPLICATION GUIDE

Depending on manufacture and model, some engine components do change. Please check with Autodata or the manufacturer's data before use.

Component 1, 2, 7, 8, 9, 11 = Fuel Pump Pulley Puller

Use components (1, 2, 7, 8, 9 & 11) to pull the fuel pump pulley off the fuel pump and push the pump out. Use in combination with 10 and 18 to allow the pump to be removed without disturbing the camshaft drive chain. Early pulleys use the screw in legs (11), latter pulleys require the hooked legs (1)

Use component (10) to remove the fuel pump cover.

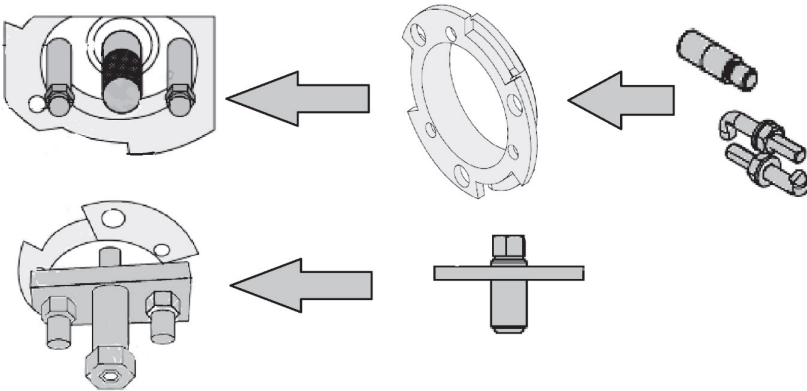

COMPONENTS 3 & 10 = FRONT COVER ALIGNMENT TOOL - FORD

Component 3 is used to align the front engine cover with the front crankshaft seal removed and all bolts loose. Use component 10 to remove old seal prior to alignment and to fit the new seal after alignment.

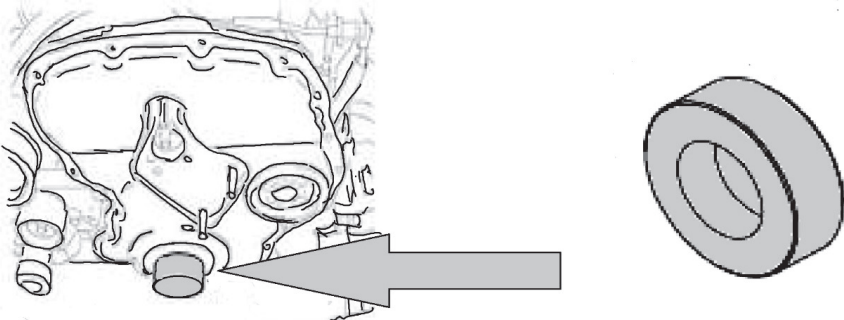

9. PROCEDURE AND APPLICATION GUIDE

COMPONENT 4 = FLYWHEEL LOCKING PIN

Component (4) are used to lock the flywheel in its timed position. The modified locking pin is now a single inter changeable pin instead of two separate pins

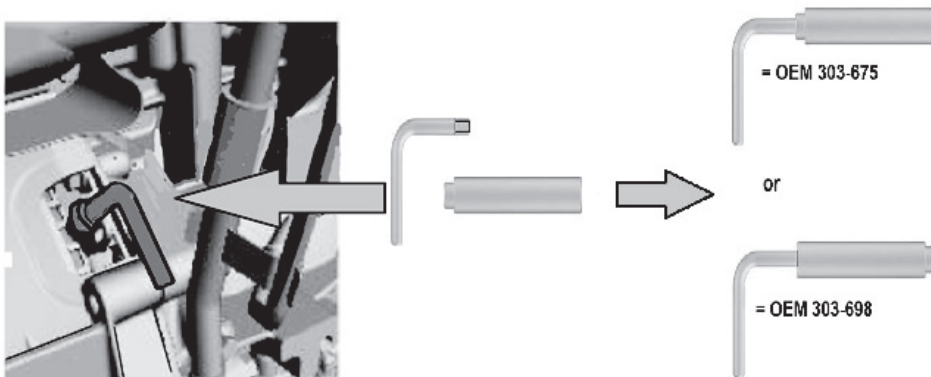

COMPONENT 5 = CAMSHAFT SETTING PIN X2

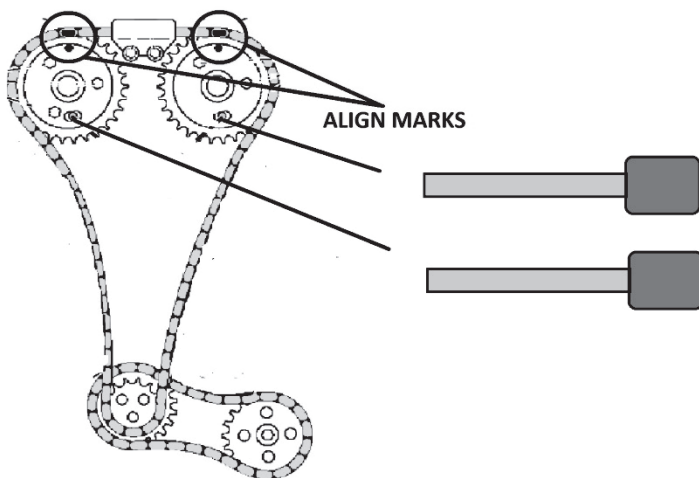

9. PROCEDURE AND APPLICATION GUIDE

COMPONENT 6 = FORD OIL PUMP ALIGNMENT TOOL

Use to align the oil pump as shown.

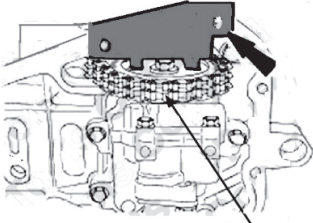

PUMP SPROCKET

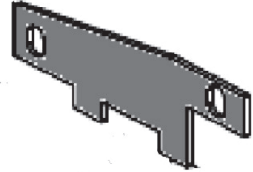
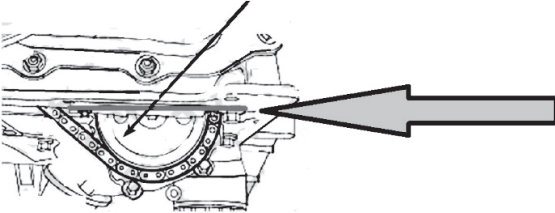

COMPONENT 13 = FLYWHEEL LOCKING PIN

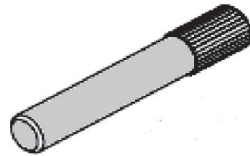
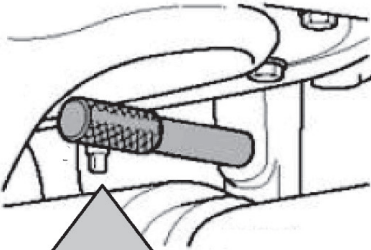

9. PROCEDURE AND APPLICATION GUIDE

COMPONENT 14 = CAMSHAFT SETTING PIN (5MM)

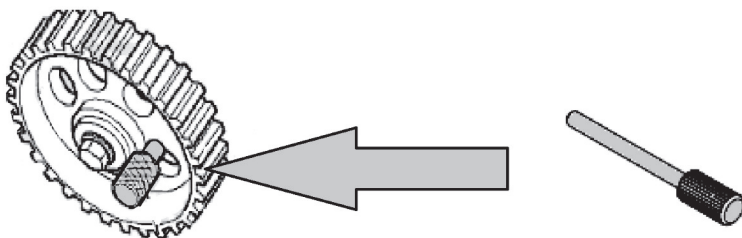

COMPONENT 12 = LOCKING PIN (8MM)

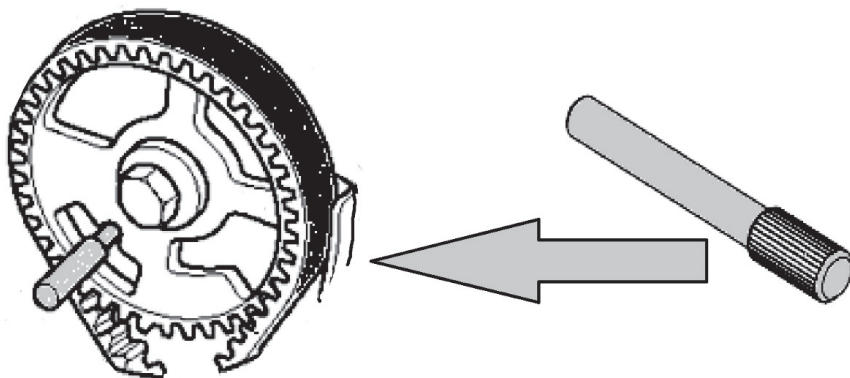

9. PROCEDURE AND APPLICATION GUIDE

COMPONENT 17 = CRANKSHAFT SETTING TOOL

Used to set and hold the crankshaft

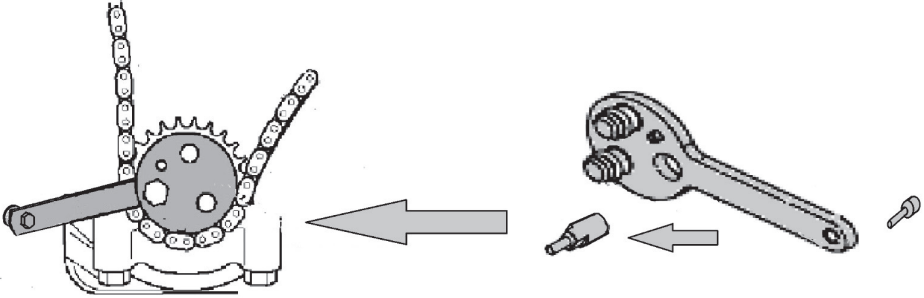

Please note images are for guidance only and subject to change.

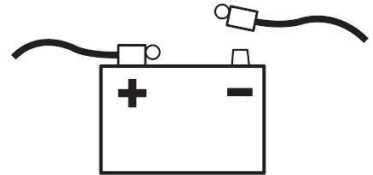

10. EXPLANATION OF SYMBOLS

10.1 EXPLANATION OF SYMBOLS



Read the guide.



Refer to website.

CONTACTS

Draper Tools Limited, Hursley Road,
Chandler's Ford, Eastleigh, Hampshire. SO53 1YF. U.K.

Helpline: (023) 8049 4344

Sales Desk: (023) 8049 4333

Internet: drapertools.com

E-mail: sales@drapertools.com

General Enquiries: (023) 8026 6355

Service/Warranty Repair Agent:

For aftersales servicing or warranty repairs, please contact the
Draper Tools Helpline for details of an agent in your local area.

YOUR DRAPER STOCKIST

MCDB0618

©Published by Draper Tools Limited.

No part of this publication may be reproduced, stored in a retrieval system or transmitted in any form or by any means, electronic, mechanical photocopying, recording or otherwise without prior permission in writing from Draper Tools Ltd.