

**DRAPER**<sup>®</sup>  
*Expert*



  
BRITISH  
MADE

APPLICATION GUIDE FOR:  
TIMING CHAIN

# WEAR KIT

19213



This document is part of the product, keep it for the life of the product passing it on to any subsequent holder of the product. Read all information before operating product.

This guide has been compiled by Draper Tools describing the purpose for which the product has been designed, and contains necessary information to ensure its correct and safe use. By following the information contained in this guide, it will ensure both product and operator safety, together with longer life of the product itself.

All photographs and drawings in this guide are supplied by Draper Tools to help illustrate the operation of the product.

Whilst every effort has been made to ensure the accuracy of information contained in this guide, the Draper Tools policy of continuous improvement determines the right to make modifications without prior warning.

# 1. TITLE PAGE

---

## 1.1 INTRODUCTION:

**USER GUIDE FOR: Timing Chain Wear Kit**

**Stock No: 19213**

**Part No: ETK245**

## 1.2 REVISIONS:

**Date first published June 2018.**

---

---

---

---

As our user manuals are continually updated, users should make sure that they use the very latest version.

**Downloads are available from:** <http://drapertools.com>

Draper Tools Limited  
Hursley Road  
Chandler's Ford  
Eastleigh  
Hampshire  
SO53 1YF  
UK

**Website:** [drapertools.com](http://drapertools.com)

**Product Helpline:** +44 (0) 23 8049 4344

**General Fax:** +44 (0) 23 8026 0784

## 1.3 UNDERSTANDING THIS GUIDES SAFETY CONTENT:

**WARNING!** – Information that draws attention to the risk of injury or death.

**CAUTION!** – Information that draws attention to the risk of damage to the product or surroundings.

## 1.4 COPYRIGHT © NOTICE:

Copyright © Draper Tools Limited.

Permission is granted to reproduce this publication for personal and educational use only. Commercial copying, redistribution, hiring or lending is prohibited.

No part of this publication may be stored in a retrieval system or transmitted in any other form or means without written permission from Draper Tools Limited.

In all cases this copyright notice must remain intact.

## 2. CONTENTS

---

<b>1. TITLE PAGE</b>	
1.1 INTRODUCTION .....	2
1.2 REVISION HISTORY .....	2
1.3 UNDERSTANDING THIS GUIDE.....	2
1.4 COPYRIGHT NOTICE .....	2
<b>2. CONTENTS</b>	
2.1 CONTENTS .....	3
<b>3. GUARANTEE</b>	
3.1 GUARANTEE .....	4
<b>4. GENERAL PRODUCT INFORMATION</b>	
4.1 GENERAL PRODUCT INFORMATION .....	5
<b>5. HEALTH AND SAFETY INFORMATION</b>	
5.1 GENERAL SAFETY INSTRUCTIONS FOR USE	
<b>Personal safety</b> .....	6
<b>6. CONTENTS</b>	
6.1 PARTS DRAWING AND LISTING .....	7
<b>7. APPLICATION</b>	
7.1 PRODUCT APPLICATION AND COMPATIBILITY LISTING .....	8
<b>8. PREPARATION</b>	
8.1 ADVISORIES BEFORE USE .....	9
<b>9. PROCEDURE AND APPLICATION GUIDE</b>	
9.1 APPLICATION GUIDANCE .....	10
<b>10. EXPLANATION OF SYMBOLS</b>	
10.1 EXPLANATION OF SYMBOLS .....	11

## 3. GUARANTEE

---

### 3.1 GUARANTEE

Draper tools have been carefully tested and inspected before shipment and are guaranteed to be free from defective materials and workmanship.

Should the tool develop a fault, please return the complete tool to your nearest distributor or contact:

**Draper Tools Limited, Chandler's Ford, Eastleigh, Hampshire, SO53 1YF. England.**

**Telephone Sales Desk: (023) 8049 4333** or:

**Product Helpline (023) 8049 4344.**

A proof of purchase must be provided.

If upon inspection it is found that the fault occurring is due to defective materials or workmanship, repairs will be carried out free of charge. This guarantee period covering parts/labour is 12 months from the date of purchase except where tools are hired out when the guarantee period is 90 days from the date of purchase. This guarantee does not apply to normal wear and tear, nor does it cover any damage caused by misuse, careless or unsafe handling, alterations, accidents, or repairs attempted or made by any personnel other than the authorised Draper warranty repair agent.

Note: If the tool is found not to be within the terms of warranty, repairs and carriage charges will be quoted and made accordingly.

This guarantee applies in lieu of any other guarantee expressed or implied and variations of its terms are not authorised.

Your Draper guarantee is not effective unless you can produce upon request a dated receipt or invoice to verify your proof of purchase within the guarantee period.

Please note that this guarantee is an additional benefit and does not affect your statutory rights.

**Draper Tools Limited.**

## 4. GENERAL PRODUCT INFORMATION

---

This product is designed to be used correctly and with care for the purpose for which it is intended. No liability is accepted by Draper Tools Limited for incorrect use or application of any of our products, and Draper Tools Limited cannot be held responsible for any damage to personnel, property or equipment when using this product. Incorrect use will also invalidate any warranty.

The applications database and any instructional information provided has been designed to offer general guidance for a particular product's use and while all attention is given to the accuracy of the data, no project should be attempted without referring first to the manufacturer's technical documentation (workshop or instruction manual) or the use of a recognised authority such as Autodata.

It is our policy to continually improve our products and thus we reserve the right to alter specifications and components without prior notice. It is the responsibility of the user to ensure the suitability of the product and information prior to use.

## 5. HEALTH AND SAFETY INFORMATION

---

### GENERAL SAFETY INSTRUCTIONS

**Warning:** Please read all safety warnings and all details carefully. Failure to follow the warnings may result in serious injury or major component damage.

**Important:** Draper Tools recommends that this product should not be modified or used for any application other than that for which it was designed.

**Save all warnings and instructions for future reference.**

#### 1) Personal safety

- a) Stay alert, watch what you are doing and use common sense when using this product. Do not use this product while you are tired or under the influence of drugs, alcohol or any medication. A moment of inattention while using this product may result in serious personal injury.
- b) Use personal protective equipment as necessary.
- c) Check and remove any part of the product before turning/testing the engine. A part left attached to a rotating part of the engine may result in personal injury or major component damage.
- d) Carefully clean the tool components after every use.
- f) Keep the tool components safe and tidy.
- g) Do not use this product for any purpose other than for which it is designed.

**Warning!** Some of the packaging materials used may be harmful to children. Do not leave any of these materials in the reach of children.

If any of the packaging is to be thrown away, make sure it is disposed of correctly; according to local regulations.

## 6. CONTENTS

---

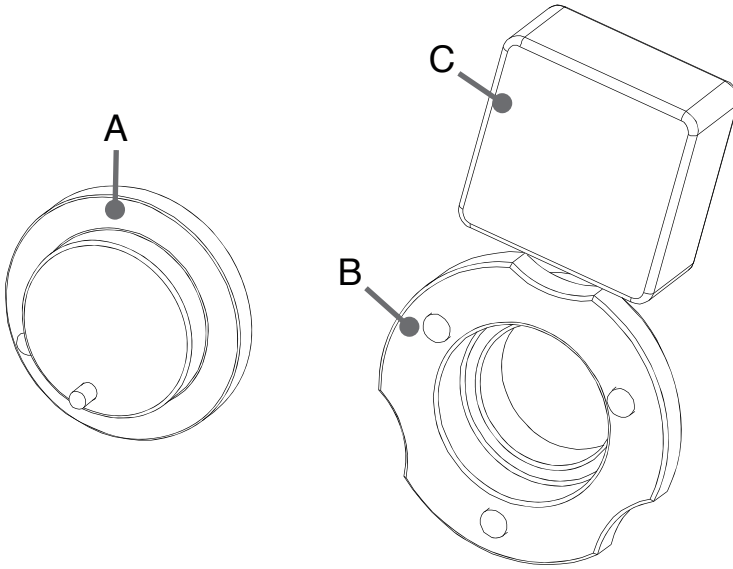

ITEM	DESCRIPTION	OEM	STOCK No.
A	Exhaust Camshaft Holding Disc	T10550/1	35645
B	Inclinometer Mounting Boss	T10550/3	35646
C	Digital Inclinometer	N/A	35647

## 7. APPLICATION

---

The **19213** has been developed as a **timing chain wear kit** for the vehicles listed below. Allows the user to check the amount of wear in the timing chain with minimal strip down of engine components. If the angle reading shown exceeds that of the manufacturers recommended amount then the camshaft drive chain and elements must be replaced.

### **Used on the following Vehicles:**

**Volkswagen Passat 2009 - 2015 TSI**

**Volkswagen Polo 2010 - 2014 TSI BlueMotion Technology**

**Volkswagen Scirocco 2008 - 2016 TSI EcoFuel**

**Volkswagen Sharan 2010 - 2015 TSI FlexFuel**

**Volkswagen Tiguan 2009 - 2016 TSI FlexFuel BlueMotion Technology**

**Volkswagen Touran 2008 - 2015 TSI BlueMotion**

**Volkswagen Beetle 2011 - 2017 GTI**

**Volkswagen CC 2011 - 2015 TSI/BlueMotion Technology**

**Volkswagen Eos 2008 - 2015**

**Volkswagen Golf 2007 - 2016**

**Volkswagen Jetta 2011 - 2017**

### **Engine Codes:**

**1.4cc**

**CAXA, CTHD, CDGA, CKMA, CAVB, CAVE, CTHE, CAVC, CMSB,  
CAVA, CTHA, CAVD, CTHB, CTHC, CTKA**



## 8. PREPARATION

---

The following is for guidance only. Please refer to OEM derived data such as the vehicle manufacturer's own data or Autodata. The use of this product is purely down to the user's discretion and Draper Tools Limited cannot be held responsible for any damage caused what so ever.

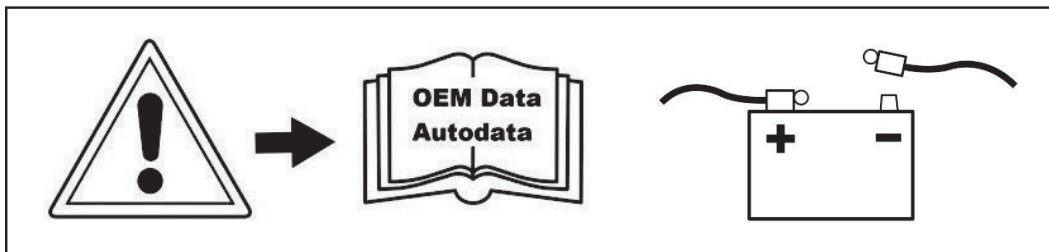

## 9. PROCEDURE AND APPLICATION GUIDE

Depending on manufacture and model, some engine components do change. Please check with Autodata or the manufacturer's data before use.

### Instructions for use:

- Always refer to manufacturer specific data and instructions.
- Gain access to the front of the engine requires removal of the right hand front wheel and inner wheel arch and pipe work.

### Components A: Exhaust Camshaft Holding Disc

Remove the cover plates from both camshafts and check the holes in the camshafts are positioned as shown and fit component A as shown.

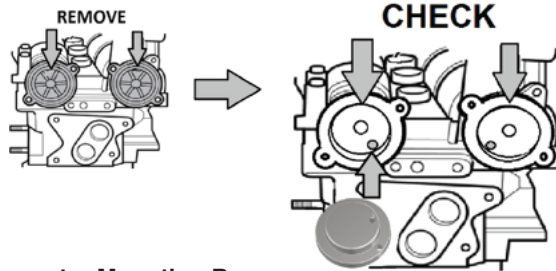

### Component B Inclinator Mounting Boss

Fit component B with the magnets facing the front crankshaft pulley and attach B with the flat (F) facing down as shown.

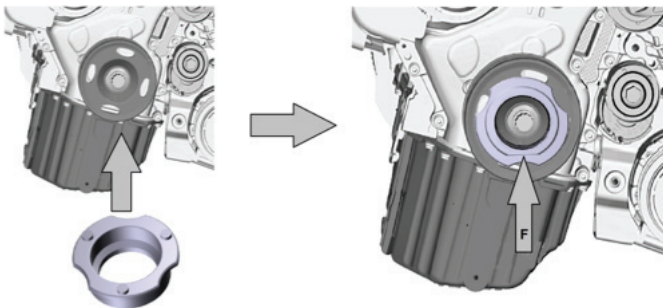

### Component C Inclinator

Component c is used to digitally check the number of degrees the crankshaft can be turned with the exhaust cam shaft locked. This figure indicates the amount the chain has stretched. Using the magnets in the base of the C attach it to the flat on the mounting boss as shown.

NOTE: C will be upside down but will still be easy to read.

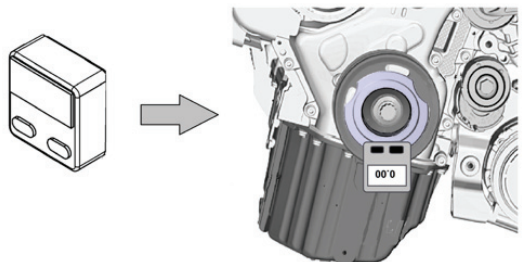

Please note images are for guidance only and subject to change.

## Instruction for measurement

Using a suitable Bi-directional Torque wrench set to 40Nm and socket turn the crankshaft in a clockwise direction till the wrench clicks. Switch on the inclinometer and zero it.

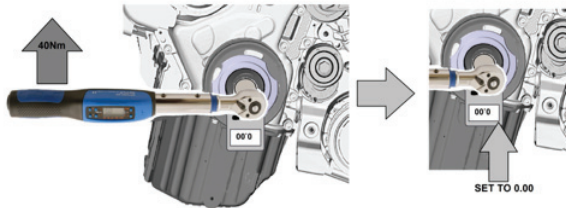

Now set the torque wrench to work in a left hand direction and set it to 40Nm, turn the crank in an anticlockwise direction till the torque wrench clicks and read the angle from the Inclinometer. This is the angle of stretch which must be compared to the manufacturer's tolerance.

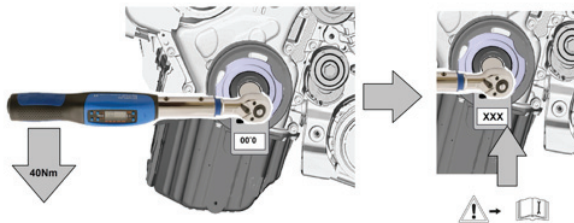

If the chain has stretched more than the manufacturers recommended limit the chain must be replaced use kit K00285

**Please note images are for guidance only and subject to change.**

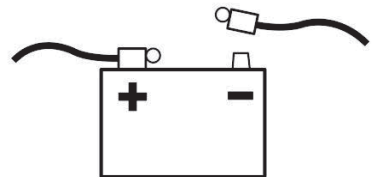

## 10. EXPLANATION OF SYMBOLS

### 10.1 EXPLANATION OF SYMBOLS



Read the guide.



Refer to website.

# CONTACTS

Draper Tools Limited, Hursley Road,  
Chandler's Ford, Eastleigh, Hampshire. SO53 1YF. U.K.

Helpline: (023) 8049 4344

Sales Desk: (023) 8049 4333

Internet: [drapertools.com](http://drapertools.com)

E-mail: [sales@drapertools.com](mailto:sales@drapertools.com)

General Enquiries: (023) 8026 6355

Service/Warranty Repair Agent:

For aftersales servicing or warranty repairs, please contact the  
Draper Tools Helpline for details of an agent in your local area.

YOUR DRAPER STOCKIST

CMDB0618

©Published by Draper Tools Limited.

No part of this publication may be reproduced, stored in a retrieval system or transmitted in any form or by any means, electronic, mechanical photocopying, recording or otherwise without prior permission in writing from Draper Tools Ltd.