

**DRAPER**<sup>®</sup>

**D20**  
MULTI-TOOL BATTERY SYSTEM

GB

20V  
**PRUNING  
SAW**

92422



CE

These instructions accompanying the product are the original instructions. This document is part of the product, keep it for the life of the product passing it on to any subsequent holder of the product. Read all these instructions before assembling, operating or maintaining this product.

This manual has been compiled by Draper Tools describing the purpose for which the product has been designed, and contains all the necessary information to ensure its correct and safe use. By following all the general safety instructions contained in this manual, it will ensure both product and operator safety, together with longer life of the product itself.

All photographs and drawings in this manual are supplied by Draper Tools to help illustrate the operation of the product.

Whilst every effort has been made to ensure the accuracy of information contained in this manual, the Draper Tools policy of continuous improvement determines the right to make modifications without prior warning.

# 1. TITLE PAGE

---

## 1.1 INTRODUCTION:

**USER MANUAL FOR: 20V Pruning Saw**

**Stock No:92422**

**Part No:D20G/RS**

## 1.2 REVISIONS:

---

**Date first published July 2019.**

---

---

---

---

As our user manuals are continually updated, users should make sure that they use the very latest version.

**Downloads are available from:** <http://drapertools.com/manuals>

Draper Tools Limited

Hursley Road

Chandler's Ford

Eastleigh

Hampshire

SO53 1YF

UK

**Website:** [drapertools.com](http://drapertools.com)

**Product Helpline:** +44 (0) 23 8049 4344

**General Fax:** +44 (0) 23 8026 0784

## 1.3 UNDERSTANDING THIS MANUALS SAFETY CONTENT:

**WARNING!** – Information that draws attention to the risk of injury or death.

**CAUTION!** – Information that draws attention to the risk of damage to the product or surroundings.

## 1.4 COPYRIGHT © NOTICE:

Copyright © Draper Tools Limited.

Permission is granted to reproduce this publication for personal and educational use only. Commercial copying, redistribution, hiring or lending is prohibited.

No part of this publication may be stored in a retrieval system or transmitted in any other form or means without written permission from Draper Tools Limited.

In all cases this copyright notice must remain intact.

---

## 2. CONTENTS

---

<b>1. TITLE PAGE</b>	
1.1 INTRODUCTION.....	2
1.2 REVISION HISTORY .....	2
1.3 UNDERSTANDING THIS MANUAL .....	2
1.4 COPYRIGHT NOTICE .....	2
<b>2. CONTENTS</b>	
2.1 CONTENTS.....	3
<b>3. WARRANTY</b>	
3.1 WARRANTY.....	4
<b>4. INTRODUCTION</b>	
4.1 SCOPE.....	5
4.2 SPECIFICATION.....	5
4.3 HANDLING & STORAGE.....	5
<b>5. HEALTH AND SAFETY INFORMATION</b>	
5.1 GENERAL SAFETY INSTRUCTIONS FOR POWER TOOL USE .....	6-7
5.2 SAFETY INSTRUCTIONS FOR RECIPROCATING SAWS.....	7-8
5.3 RESIDUAL RISK.....	8
5.4 SAFETY INSTRUCTIONS FOR MAINS POWERED CHARGERS & BATTERY PACKS .....	8-9
5.5 CONNECTION TO THE POWER SUPPLY (CHARGER) .....	10
<b>6. TECHNICAL DESCRIPTION</b>	
6.1 IDENTIFICATION .....	11
<b>7. UNPACKING AND CHECKING</b>	
7.1 PACKAGING .....	12
7.2 D20 MULTI-TOOL INTERCHANGEABLE BATTERY SYSTEM .....	12
7.3 WHAT'S IN THE BOX.....	12
<b>8. PREPARING THE PRUNING SAW</b>	
8.1 BATTERY PACK CHARGING .....	13-14
8.2 BATTERY PACK PROTECTION FEATURES .....	14
8.3 BATTERY PACK CHARGE STATUS.....	14
8.4 BATTERY LIFE EFFICIENCY AND CHARGING ADVICE .....	14
<b>9. BASIC PRUNING SAW OPERATIONS</b>	
9.1 SWITCH AND VARIABLE STROKE RATE CONTROL.....	15
9.2 QUICK CHANGE BLADE FUNCTION .....	15
9.3 ORBITAL SELECTION SWITCH.....	15
9.4 ADJUSTABLE SOLE PLATE LOCKING SWITCH .....	15
9.5 FLUSH CUTTING.....	16
9.6 GENERAL CUTTING .....	16
<b>10. MAINTENANCE AND TROUBLESHOOTING</b>	
10.1 MAINTENANCE .....	17
10.2 TROUBLESHOOTING .....	17
<b>11. OPTIONAL ACCESSORIES</b>	
11.1 OPTIONAL ACCESSORIES.....	17
<b>12. DISPOSAL</b>	
12.1 DISPOSAL.....	18
12.2 BATTERY PACK DISPOSAL INFORMATION.....	18
<b>13. EXPLANATION OF SYMBOLS</b>	
13.1 EXPLANATION OF SYMBOLS .....	10
<b>DECLARATION OF CONFORMITY .....</b>	<b>ENCLOSED</b>

## 3. WARRANTY

---

### 3.1 WARRANTY

Draper tools have been carefully tested and inspected before shipment and are guaranteed to be free from defective materials and workmanship.

Should the tool develop a fault, please return the complete tool to your nearest distributor or contact:

**Draper Tools Limited, Chandler's Ford, Eastleigh, Hampshire, SO53 1YF. England.**

**Telephone Sales Desk: (023) 8049 4333 or:**

**Product Helpline (023) 8049 4344.**

A proof of purchase must be provided.

If upon inspection it is found that the fault occurring is due to defective materials or workmanship, repairs will be carried out free of charge. This warranty period covering labour is 12 months from the date of purchase except where tools are hired out when the warranty period is 90 days from the date of purchase. The warranty is extended to 24 months from the date of purchase for parts only. This warranty does not apply to any consumable parts, any type of battery or normal wear and tear, nor does it cover any damage caused by misuse, careless or unsafe handling, alterations, accidents, or repairs attempted or made by any personnel other than the authorised Draper warranty repair agent.

Note: If the tool is found not to be within the terms of warranty, repairs and carriage charges will be quoted and made accordingly.

This warranty applies in lieu of any other warranty expressed or implied and variations of its terms are not authorised.

Your Draper warranty is not effective unless you can produce upon request a dated receipt or invoice to verify your proof of purchase within the warranty period.

Please note that this warranty is an additional benefit and does not affect your statutory rights.

**Draper Tools Limited.**

# 4. INTRODUCTION

---

## 4.1 SCOPE

This pruning saw is designed to cut branches, logs, wood and thin metal, including sheet materials and window surrounds.

As part of our core range, this product is suitable for enthusiasts and tradespeople alike. Any application other than that it was intended for, is considered misuse.

## 4.2 SPECIFICATION

Stock No. ....	92422
Part No. ....	D20G/RS
Cutting capacities:	
With branch holder .....	35mm
without branch holder .....	60mm
Metal .....	3mm
Stroke length .....	13mm
Strokes per minute (no load) .....	0-2200s/min
Sound pressure level (LpA)*: .....	84.8dB(A)
Sound power level (LWA)**: .....	95.8dB(A)
Uncertainty (K): .....	3dB(A)
Vibration level cutting boards with a saw blade:.....	20.4m/s <sup>2</sup> , K=1.5m/s <sup>2</sup>
Vibration level cutting wooden beams with a saw blade: .....	20.59m/s <sup>2</sup> , K=1.5m/s <sup>2</sup>
Weight (machine only):.....	1.4kg

\* *Continuous A-Weighted Sound Pressure Level at the workstation in accordance to and declared according to EN60745.*

\*\* *The typical A-weighted noise level determined according to EN60745.*

## 4.3 HANDLING & STORAGE

- Care must be taken when handling this product.
  - Dropping this power tool could have an effect on its accuracy and could also result in personal injury. This product is not a toy and must be respected.
- Environmental conditions can have a detrimental effect on this product if neglected.
  - Exposure to damp air can gradually corrode components.
  - If the product is unprotected from dust and debris, components will become clogged.
  - If not cleaned and maintained correctly or regularly, the machine will not perform at its best.

## 5. HEALTH AND SAFETY INFORMATION

---

### 5.1 GENERAL POWER TOOL SAFETY WARNINGS

**WARNING** Read all safety warnings, instructions, illustrations and specifications provided with this power tool. *Failure to follow all instructions listed below may result in electric shock, fire and/or serious injury.*

**Save all warnings and instructions for future reference.**

*The term "power tool" in the warnings refers to your mains-operated (corded) power tool or battery-operated (cordless) power tool.*

#### **Work area safety**

**Keep work area clean and well lit.** *Cluttered or dark areas invite accidents.*

**Do not operate power tools in explosive atmospheres, such as in the presence of flammable liquids, gases or dust.** *Power tools create sparks which may ignite the dust or fumes.*  
**Keep children and bystanders away while operating a power tool.** *Distractions can cause you to lose control.*

#### **Electrical safety**

**Power tool plugs must match the outlet. Never modify the plug in any way. Do not use any adapter plugs with earthed (grounded) power tools.** *Unmodified plugs and matching outlets will reduce risk of electric shock.*

**Avoid body contact with earthed or grounded surfaces, such as pipes, radiators, ranges and refrigerators.** *There is an increased risk of electric shock if your body is earthed or grounded.*  
**Do not expose power tools to rain or wet conditions.** *Water entering a power tool will increase the risk of electric shock.*

**Do not abuse the cord. Never use the cord for carrying, pulling or unplugging the power tool. Keep cord away from heat, oil, sharp edges or moving parts.** *Damaged or entangled cords increase the risk of electric shock.*

**When operating a power tool outdoors, use an extension cord suitable for outdoor use.** *Use of a cord suitable for outdoor use reduces the risk of electric shock.*

**If operating a power tool in a damp location is unavoidable, use a residual current device (RCD) protected supply.** *Use of an RCD reduces the risk of electric shock.*

#### **Personal safety**

**Stay alert, watch what you are doing and use common sense when operating a power tool. Do not use a power tool while you are tired or under the influence of drugs, alcohol or medication.** *A moment of inattention while operating power tools may result in serious personal injury.*

**Use personal protective equipment. Always wear eye protection.** *Protective equipment such as a dust mask, non-skid safety shoes, hard hat or hearing protection used for appropriate conditions will reduce personal injuries.*

**Prevent unintentional starting. Ensure the switch is in the off-position before connecting to power source and/or battery pack, picking up or carrying the tool.** *Carrying power tools with your finger on the switch or energising power tools that have the switch on invites accidents.*

**Remove any adjusting key or wrench before turning the power tool on.** *A wrench or a key left attached to a rotating part of the power tool may result in personal injury.*

**Do not overreach. Keep proper footing and balance at all times.** *This enables better control of the power tool in unexpected situations.*

**Dress properly. Do not wear loose clothing or jewellery. Keep your hair and clothing away from moving parts.** *Loose clothes, jewellery or long hair can be caught in moving parts.*

**If devices are provided for the connection of dust extraction and collection facilities, ensure these are connected and properly used.** *Use of dust collection can reduce dust-related hazards.*

**Do not let familiarity gained from frequent use of tools allow you to become complacent and ignore tool safety principles.** *A careless action can cause severe injury within a fraction of a second.*

## 5. HEALTH AND SAFETY INFORMATION

---

### **Power tool use and care**

**Do not force the power tool. Use the correct power tool for your application.** *The correct power tool will do the job better and safer at the rate for which it was designed.*

**Do not use the power tool if the switch does not turn it on and off.** *Any power tool that cannot be controlled with the switch is dangerous and must be repaired.*

**Disconnect the plug from the power source and/or remove the battery pack, if detachable, from the power tool before making any adjustments, changing accessories, or storing power tools.** *Such preventive safety measures reduce the risk of starting the power tool accidentally.*

**Store idle power tools out of the reach of children and do not allow persons unfamiliar with the power tool or these instructions to operate the power tool.** *Power tools are dangerous in the hands of untrained users.*

**Maintain power tools and accessories. Check for misalignment or binding of moving parts, breakage of parts and any other condition that may affect the power tool's operation. If damaged, have the power tool repaired before use.** *Many accidents are caused by poorly maintained power tools.*

**Keep cutting tools sharp and clean.** *Properly maintained cutting tools with sharp cutting edges are less likely to bind and are easier to control.*

**Use the power tool, accessories and tool bits etc. in accordance with these instructions, taking into account the working conditions and the work to be performed.** *Use of the power tool for operations different from those intended could result in a hazardous situation.*

**Keep handles and grasping surfaces dry, clean and free from oil and grease.** *Slippery handles and grasping surfaces do not allow for safe handling and control of the tool in unexpected situations.*

### **Service**

**Have your power tool serviced by a qualified repair person using only identical replacement parts.** *This will ensure that the safety of the power tool is maintained.*

## 5.2 SAFETY INSTRUCTIONS FOR RECIPROCATING SAWS

- Use the saw with branch holder in situ or use another practical way to secure and support the workpiece to a stable platform. Holding the workpiece by hand or against your body leaves it unstable and may lead to loss of control.

### **CHANGING BLADES**

- Ensure the battery is removed before changing blades, and take care to prevent entrapment of the fingers between the blade and the shoe. Ensure the blade is secure before use.
- Use the appropriate blade for the material being cut. Different blades are available from your Draper stockist.
- Only use blades in perfect working condition. Discard and replace any cracked or bent saw blades.

### **WHEN SAWING**

- Allow sufficient clearance beneath the work to ensure the blade does not come into contact with the floor, bench etc.
- When cutting branches ensure work area is clear to avoid damage or injury to bystanders from falling debris

## 5. HEALTH AND SAFETY INFORMATION

---

- Switching off. Never place the saw on a table or bench if it has not completely stopped. The saw blade will continue to operate for a short time after the trigger has been released to stop the saw.
- Cutting of pipes. Use caution when cutting hollow pipe and do not cut material where the blade can enter the pipe when fully retracted, this can cause the blade to strike the inside of the pipe causing the user to experience unexpected reaction forces.
- Cutting into walls. Do not cut through walls or cavities without checking for hidden electrical wires or water pipes etc.
- Do not attempt to remove tool from work until the blade has completely stopped and allow time for it to cool before touching the blade immediately after use.
- Use clamps and vices to secure the workpiece where possible.
- Cutting sheet materials. Do not cut material less than at least twice the pitch of the saw blade. At least two teeth must be in contact with the work at all times.
- Beware of foreign objects. When cutting pre-used wood, ensure all nails have been removed beforehand. Nails will damage the wood saw blade, if in doubt change to wood/metal cutting blade.
- Cooling agents. When cutting metals, always use a cooling agent i.e. cutting/soluble oil.
- Do not attempt to saw small objects including those which cannot be properly secured.

### 5.3 RESIDUAL RISK

**Important:** Although the safety instructions and operating manuals for our tools contain extensive instructions of safe working with power tools, every power tool involves a certain residual risk which

can not be completely excluded by safety mechanisms. Power tools must therefore always be operated with caution!

### 5.4 SAFETY INSTRUCTIONS FOR MAINS POWERED CHARGERS & BATTERY PACKS

#### Chargers

- The charger is for indoor use only.
- Prior to plugging the charger in to the supply, check that the plug and the cable are in good repair. If either are damaged, have the defective item replaced immediately by a suitably qualified person. If the casing of the battery charger is damaged, it is good policy to have the charger checked over by a suitably qualified person.
- Only use a correctly rated mains outlet to provide power, do not plug into site generators, attach to engine generators or D.C. sources. Do not use a mains socket outlet that is not switched.
- Use the correct Draper charger in conjunction with it's corresponding battery pack (consult the Draper website for more information or to find your local stockist).
- Do not charge any other batteries with Draper chargers. Any other application is considered misuse.
- Do not attempt to charge battery packs that are too hot (over 30°C) or too cold (under 5°C), if these conditions apply set the battery pack aside to “normalise” before proceeding with the charging operation.
- Set up the charger and cable in a safe place where it won't be knocked, tripped over, stepped on, etc. and where it is well ventilated. Make sure the ventilation slots in the charger case are not obstructed, plug the charger into the socket outlet.
- Inspect the battery pack for damage, if it is undamaged, plug it into the charger, ensuring the correct orientation. (Most chargers and batteries have 'keys' etc, to make sure the battery pack is not inserted incorrectly, if you are having to 'force' the battery pack into the charger, the chances are you have it the wrong way round, check and try again.)



## 5. HEALTH AND SAFETY INFORMATION

---

- Switch the charger on and check that the correct indicators illuminate, allow the battery pack to charge (see the specific instructions for your charger). Once charging is complete, switch the charger off, remove the battery pack and store, repeat the procedure if you have more than one battery pack to charge.

**Caution:** When the battery charger has been continuously used, the battery charger will be hot. Once the charging has been completed, give 15 minutes rest until the next charge.

- After charging is complete, unplug the charger from the socket outlet by pulling on the plug. Do not pull on the cable. Store the charger in a dry secure place.
- If, when the charger was switched on, the correct indications did not occur, leave for two or three minutes to allow the charger to stabilise, if the correct indications occur, allow the charging cycle to proceed as normal. If no indication appears at all, switch off, remove the battery pack, unplug the charger, check that the charger contacts and the battery contacts are clean and repeat the process. If there is still no indication, switch off, remove the battery pack, unplug the charger and check the fuse. If the fuse is blown, replace and repeat the process. If the fuse blows again, or if the fuse is intact, attempt no further action. Refer the charger to a suitably qualified person for repair.

### Battery packs

- Before charging, read the instructions.
- For indoor use. Do not expose to rain.
- Only use Draper D20 battery packs with this product. Consult your Draper stockist for details.
- Do not charge any other manufacturer's battery packs using Draper chargers. Any other application is considered misuse.
- The battery must be removed from the appliance before it is recycled.
- The charger must be disconnected from the supply mains when removing the battery.
- The battery is to be disposed of in-line with local authority procedures.
- Do not use any other than the designated Draper batteries/chargers with this product.
- Do not crush, open or burn the battery. Exposure to potentially harmful materials may occur.
- In case of fire use CO<sub>2</sub> or dry chemical extinguisher.
- Do not expose to high temperatures >50°C. The battery may degrade at high temperatures.
- Charge battery in conditions between 5°C to 30°C with the specified charger designed for this battery.
- Do not use battery if it has been stored at 5°C or less. Allow it to "normalise" at room temperature before usage/charging.

### Warning!

- Leaking battery packs
  - The electrolyte in battery packs is corrosive. Avoid contact with the skin.
  - If contact is made, flush the area with running water, pat dry and seek medical attention and advice at the earliest opportunity.
  - Inform medical personnel that the contaminant is a "high alkaline, corrosive liquid".
  - If electrolyte comes into contact with the eyes, flush with copious amounts of water only. Seek medical attention immediately, relaying the information above.

## 5. HEALTH AND SAFETY INFORMATION

---

### 5.5 CONNECTION TO THE POWER SUPPLY (CHARGER SOLD SEPARATELY)

**Caution:** Risk of electric shock. Do not open.

This appliance is supplied with a moulded 3 pin mains plug for your safety. The value of the fuse fitted is marked on the pin face of the plug. Should the fuse need replacing, ensure the substitute is of the correct rating, approved to BS1362 and ASTA or BSI Kite marked.

ASTA 

BSI 

The fuse cover is removable with a small plain slot screwdriver. Ensure the fuse cover is replaced before attempting to connect the plug to an electrical outlet. If the cover is missing, a replacement must be obtained or the plug replaced with a suitable type.

If a replacement plug is to be fitted this must be carried out by a qualified electrician.

The damaged or incomplete plug, when cut from the cable should be disabled to prevent connection to a live electrical outlet.

This appliance is Class II<sup>†</sup> and is designed for connection to a power supply matching that detailed on the rating label and compatible with the plug fitted.

If an extension lead is required, use an approved and compatible lead rated for this appliance. Follow all the instructions supplied with the extension lead.

<sup>†</sup>*Double insulated : This product requires no earth connection as supplementary insulation is applied to the basic insulation to protect against electric shock in the event of failure of the basic insulation.*

#### **IMPORTANT**

**If using an extension lead, follow the instructions that came with your lead regarding maximum load while cable is wound. If in doubt, ensure that the entire cable is unwound. Using a coiled extension lead will generate heat which could melt the lead and cause a fire.**

## 6. TECHNICAL DESCRIPTION

### 6.1 IDENTIFICATION

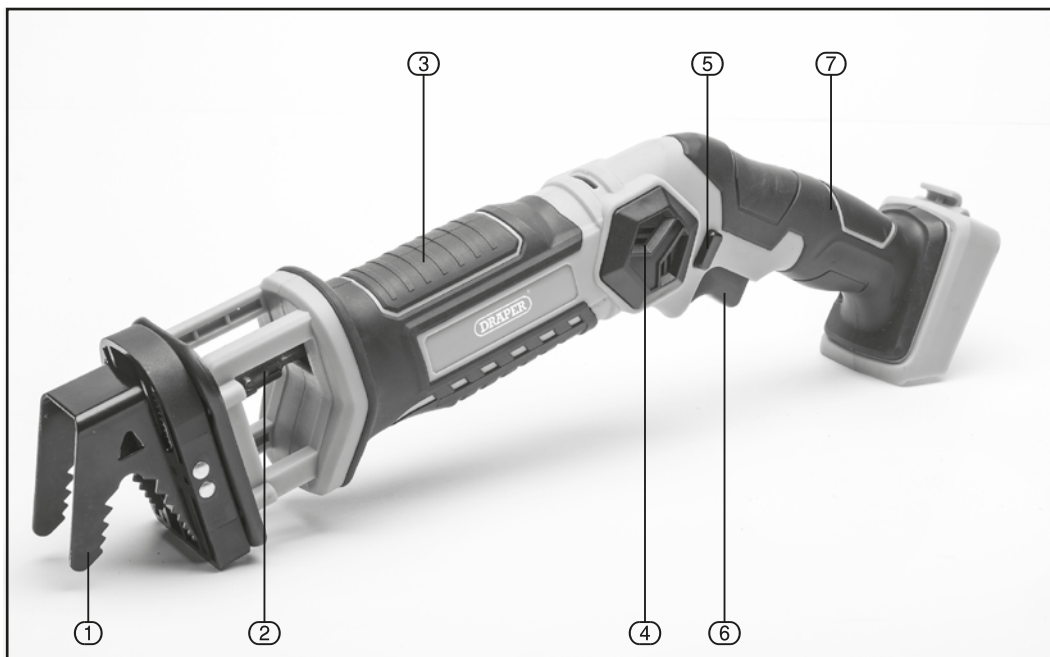

- ① Branch holder.
- ② Blade holder.
- ③ Barrel Grip.
- ④ Motor Vents.

- ⑤ Safety switch.
- ⑥ On/off switch.
- ⑦ Soft grip handle.

## 7. UNPACKING AND CHECKING

### 7.1 PACKAGING

Carefully remove the product from the packaging and examine it for any sign of damage that may have happened during shipping. Lay the contents out and check them against the parts shown below. If any part is damaged or missing, please contact the Draper Help Line (the telephone number appears on the Title page) and do not attempt to use the product.

The packaging material should be retained at least during the warranty period, in case the machine needs to be returned for repair.

#### Warning!

- Some of the packaging materials used may be harmful to children. Do not leave any of these materials in the reach of children.
- If any of the packaging is to be thrown away, make sure they are disposed of correctly, according to local regulations.

### 7.2 D20 MULTI-TOOL INTERCHANGEABLE BATTERY SYSTEM

The D20 range of tools are a range of tools suitable for enthusiasts and tradespersons alike, featuring a wide array of machines all running from the same range of batteries. Many different capacity batteries are available making sure you can balance tool weight with longevity and find a battery that meets your needs. To find out the latest range of accessories including batteries and chargers please consult the Draper website for more information or to find your local Draper stockist.



### 7.3 WHAT'S IN THE BOX

As well as the pruning saw, there are several parts not fitted or attached to it.

- ⑧ 1 x 19tpi wood/metal cutting saw blade
- ⑨ 1 x 7tpi wood cutting saw blade

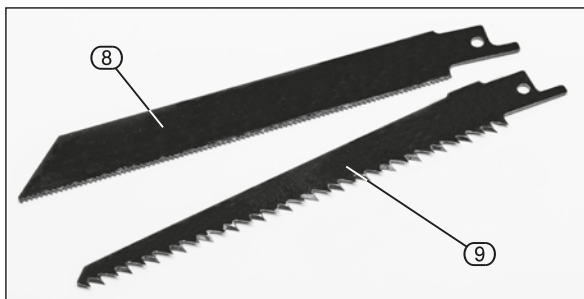

## 8. PREPARING THE PRUNING SAW

### 8.1 BATTERY PACK CHARGING – FIGS. 1 – 2

This power product is supplied “bare”, without battery pack or charger. Compatible batteries, chargers and accessories are available through Draper Tools stockists.

**Important:** Only Draper designated battery packs and chargers can be used in conjunction with this product. Use of any other third party battery packs/chargers with this product is considered misuse and will invalidate the product’s warranty.

Once connected to the mains supply, recharging of the battery can be left generally unsupervised, requiring minimal attention. Complex circuit construction monitors the battery condition, adjusting the recharge current to suit. When the recharge cycle is complete, to maintain the full capacity, a low output current will continue as required.

**Warning!** Check the condition of the charger and battery prior to each charge. If there is any sign of damage then do not commence charging, seek advice from Draper Tools.

The battery pack is supplied un-charged and must be charged before initial use.

To charge the battery pack (12), it must first be removed from the tool.

To release the battery pack:

- Press the battery release button (12.1) and gently slide the battery pack off (Fig.1).
- Plug the battery charger (11) unit into a 230V/AC 13amp three pin supply socket.
- The red LED (11.1) will illuminate to show the charger has power.
- Slide the battery into the charger (the battery is shaped to fit into the charger one way only).
- After a few seconds delay, the red LED (11.1) will flash to show that charging has begun, then illuminate solid red.

- Whilst the battery is charging, the green LED (11.2) will flash, (the red LED will go from flashing to constant red).
- When the battery is fully charged when the green LED stops flashing and remains a constant green. The red LED will extinguish.

**Caution:** Do not pull the plug out of the power supply by pulling on the cord. Make sure to grasp the plug when removing from power supply to avoid damaging the cord.

To remove the battery from the battery charger:

- Supporting the battery charger with hand, pull out the battery from the battery charger.

**Caution:** If the battery charger has been in continuous use it will be hot. Once the charging has been completed, leave the charger 15 minutes to cool until next use.

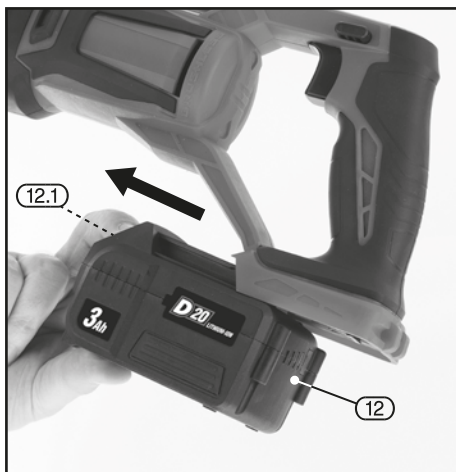

FIG.1

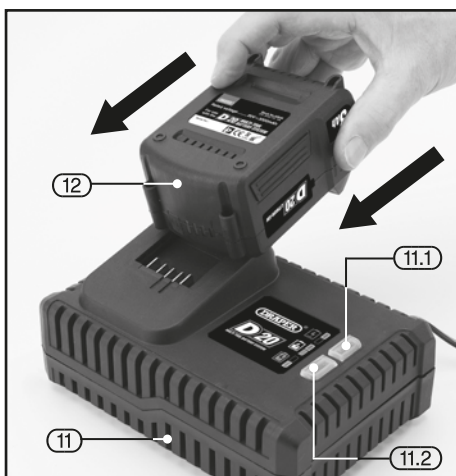

FIG.2

## 8. PREPARING THE PRUNING SAW

If the battery is charged when it is warm due to battery use or exposure to sunlight, the battery will not be recharged. In such a case, let the battery cool before charging.

If the red indicator flickers rapidly at 0.2 second intervals, check or and remove any foreign objects in the charger's battery slot. If there are no foreign objects, it is probable that the battery or charger is malfunctioning. Allow battery/charger to normalise and try again. If a fault remains after trying this then contact Draper Tools.

### 8.2 BATTERY PACK PROTECTION FEATURES

**Overcharging protection:** This feature that ensures that the battery pack can never be overcharged. When the battery pack reaches full charge capacity, the transformer/charger will automatically shut off, protecting the internal components from being damaged.

**Over-discharging protection:** This feature will stop the battery pack from discharging beyond the recommended lowest safety voltage.

**Overheating protection:** The battery pack contains an internal thermistor cut-off sensor which shuts off the battery pack should it become too hot during operation. This can happen if the tool is overloaded or being used for extended periods. Up to 30 minutes cooling time may be required, depending on ambient temperature.

**Current protection:** Should the battery be overloaded and the maximum current draw be exceeded, the battery will shut off to protect the internal components. The battery pack will resume working once excessive current draw has returned to normal, safe level.

**Short circuit protection:** If, for any reason, the battery pack was to short circuit, the short circuit protection would immediately stop the battery pack from operating.

### 8.3 BATTERY PACK CHARGE STATUS – FIG. 3

To display the amount of charge left in the battery pack, press the charge level indicator button (12.2).

### 8.4 BATTERY LIFE EFFICIENCY AND CHARGING ADVICE

- Avoid recharging at high temperatures.  
A rechargeable battery will be hot immediately after use. If such a battery is recharged immediately after use, its internal chemical substance will deteriorate, and the battery life will be shortened. Leave the battery and recharge it after it has cooled for a while.
- The battery should only be used and/or charged when battery temperature is between 5°C and 30°C.
- The battery needs to be warmed-up or cooled down in order to prevent damage to the batteries internal components,

**Note:** If battery is too hot or too cold, allow it to 'normalise' before use or charging.

**Note:** Failure to warm up or cool down a battery could result in serious damage to the battery, charger and user.



Charge level indicator	Amount of charge remaining
	0 – 10%
	10 – 25%
	25 – 50%
	50 – 75%
	75 – 100%

FIG.3

## 9. BASIC PRUNING SAW OPERATIONS

### 9.1 SWITCH AND VARIABLE STROKE RATE CONTROL – FIG. 4

Your pruning saw is equipped with a variable speed switch to turn the saw on and off, and to control the speed.

- To start the saw depress the safety switch (5) first, then press the variable speed switch (6).
- To stop the saw, release the variable speed switch (6).
- To vary the stroke rate, simply increase or decrease the pressure on the trigger switch. The tighter the trigger switch is pressed, the higher the speed.

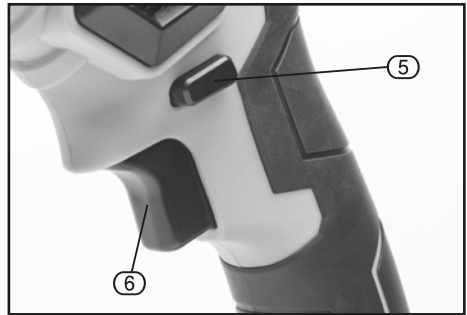

FIG.4

### 9.2 CHANGE BLADE FUNCTION – FIG. 5

Remove battery before changing blade.

Loosen the hex. socket bolt.

Slide the blade in to the blade clamp with the teeth facing downwards.

Tighten the bolt securely.

Test that the blade is held securely before replacing battery and operating.

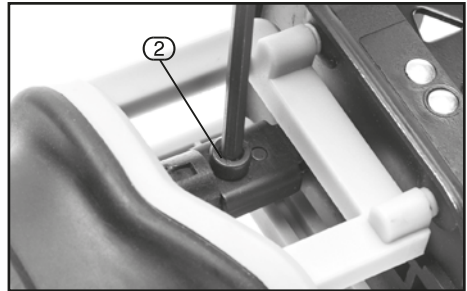

FIG.5

## 9. BASIC PRUNING SAW OPERATIONS

### 9.5 FLUSH CUTTING – FIG.8

The pruning saw with the branch holder fixes the saw onto the branch, enabling users to single-handedly and effortlessly cut through branches up to 36mm in diameter.

Remove the detachable branch holder and the wood blade will cut cleanly through branches up to 60mm in diameter.



FIG.8

### 9.6 GENERAL CUTTING

**Warning!** Before use, always check to see that the trigger is actuated properly and returns to the off position when released.

**Warning!** When sawing into walls or floors you may encounter electrical wiring. Sawing into a “live” wire will cause electric shock. Always check with a metal/voltage detector that there are no hidden hazards such as electrical cables, water or gas pipes running below the surface.

- Make sure the workpiece is firmly anchored. Clamp the workpiece to prevent slipping or moving while cutting.
- Use the appropriate type and size of blade for the workpiece material and size.
- Check for clearance beyond the workpiece so the blade will not impact another surface.
- Mark the line of cut clearly. If cutting metal, apply cutting oil on the line.
- Depress the trigger switch to start the saw and bring it to maximum desired cutting stroke rate before applying the blade to the workpiece.
- Do not force the tool. Place the sole plate firmly on the workpiece while cutting. Use only enough steady pressure on the blade to keep the saw cutting. Reduce pressure as the blade comes to the end of the cut.
- Cutting stroke rates should vary with the workpiece. Hard materials such as metals require lower stroke rates, for softer materials use higher stroke rates.
- Check wood, chip boards, building materials etc. for foreign objects (nails, screws, etc.) before sawing and remove them, if necessary.
- Position the pivoting sole plate onto the surface of the work and saw through the work applying uniform contact pressure of feed.

If the saw blade jams, switch off the tool immediately. Widen the saw cut with a suitable tool and pull out the saw blade.



# 10. MAINTENANCE AND TROUBLESHOOTING

---

## 10.1 MAINTENANCE

Regular inspection and cleaning reduces the necessity for maintenance operations and will keep your tool in good working condition.

The motor must be correctly ventilated during tool operation. Avoid blocking the air inlets and vacuum the ventilation slots regularly.

## 10.2 TROUBLESHOOTING

Problem	Possible Cause	Remedy
Saw does not work.	1. Flat battery.	1. Re-charge battery.
Blade does not locate.	1. Check blade retaining mechanism. 2. Swarf in retaining mechanism.	1. Remove blade, fully open retaining mechanism and re-insert blade. 2. Clean inside retaining mechanism with cleaning fluid.

# 11. OPTIONAL ACCESSORIES

---

## 11.1 OPTIONAL ACCESSORIES

A full range of blades are available from Draper Tools.

Please visit our website for details: [www.drapertools.com](http://www.drapertools.com)

# 12. DISPOSAL

---

## 12.1 DISPOSAL

- At the end of the machine's working life, or when it can no longer be repaired, ensure that it is disposed of according to national regulations.
- Contact your local authority for details of collection schemes in your area.

In all circumstances:

- Do not dispose of power tools with domestic waste.
- Do not incinerate.
- Do not dispose of WEEE\* as unsorted municipal waste.



\* Waste Electrical & Electronic Equipment.

## 12.2 BATTERY PACK DISPOSAL INFORMATION

### Warning!

- Do not put battery pack in fire or mutilate – cells may burst or release toxic materials.
- Do not short circuit cells, may cause burns.
- The battery pack must be removed from the appliance before it is scrapped.
- The battery pack is to be disposed of safely.
- Do not mutilate batteries, corrosive electrolyte will be released.
- Do not dispose of batteries or cells in a charged condition.

Expired batteries must be recycled/disposed of in accordance with the appropriate regulation or legislation. They should be returned to your local warranty agent/stockist.

# 13. EXPLANATION OF SYMBOLS

## 13.1 EXPLANATION OF SYMBOLS



Read the instruction manual.



Wear face mask and safety glasses.



Wear ear defenders.



Wear protective gloves.



Long and loose hair must be contained or securely tied back.



Do not abandon into the environment.



Keep out of the reach of children.



**Warning!**



Single value noise marking.  
*(Maximum declared A-Weighted sound power level in decibels).*



Class II construction  
*(Double insulated).*



WEEE –  
Waste Electrical &  
Electronic Equipment.  
*Do not dispose of Waste Electrical & Electronic Equipment in with domestic rubbish.*



Lithium-ion product.

**Li-ion**



Do not incinerate or throw onto fire.



For indoor use only.  
Do not expose to rain.



Fuse.



Polarity indication.



Rated voltage.

# CONTACTS

Draper Tools Limited, Hursley Road,  
Chandler's Ford, Eastleigh, Hampshire. SO53 1YF. U.K.

Helpline: (023) 8049 4344

Sales Desk: (023) 8049 4333

Internet: [drapertools.com](http://drapertools.com)

E-mail: [sales@drapertools.com](mailto:sales@drapertools.com)

General Enquiries: (023) 8026 6355

Service/Warranty Repair Agent:

For aftersales servicing or warranty repairs, please contact the Draper Tools Helpline for details of an agent in your local area.

## YOUR DRAPER STOCKIST

TAKC0719

©Published by Draper Tools Limited.

No part of this publication may be reproduced, stored in a retrieval system or transmitted in any form or by any means, electronic, mechanical photocopying, recording or otherwise without prior permission in writing from Draper Tools Ltd.