

# DRAPER®

INSTRUCTIONS FOR

# 3 tonne Heavy Duty Trolley Jack

Stock No.53089, 60977

Part No.TJ3HD/B, TJ3HD/BR

**IMPORTANT:** PLEASE READ THESE INSTRUCTIONS CAREFULLY TO ENSURE THE SAFE AND EFFECTIVE USE OF THIS TOOL.



CE

DRAPER®

## GENERAL INFORMATION

This manual has been compiled by Draper Tools and is an integrated part of the product with which it is enclosed and should be kept with it for future references.

This manual describes the purpose for which the product has been designed and contains all the necessary information to ensure its correct and safe use. We recommend that this manual is read before any operation or, before performing any kind of adjustment to the product and prior to any maintenance tasks. By following all the general safety instructions contained in this manual, it will ensure both product and operator safety, together with longer life of the product itself.

All photographs and drawings in this manual are supplied by Draper Tools to help illustrate the operation of the product.

Whilst every effort has been made to ensure accuracy of information contained in this manual, the Draper Tools policy of continuous improvement determines the right to make modifications without prior warning.

# 1. TITLE PAGE

---

## **1.1 INTRODUCTION:**

USER MANUAL FOR:

## **3 TONNE HEAVY DUTY TROLLEY JACK**

Stock nos.53089, 60977.

Part no.TJ3HD/B, TJ3HD/BR.

## **1.2 REVISIONS:**

\_\_\_\_\_

Date first published July 2014

\_\_\_\_\_

\_\_\_\_\_

\_\_\_\_\_

As our user manuals are continually updated, users should make sure that they use the very latest version.

Downloads are available from: <http://www.drapertools.com/b2c/b2cmanuals.pgm>

DRAPER TOOLS LIMITED

HURSLEY ROAD

CHANDLER'S FORD

EASTLEIGH

HAMPSHIRE

SO53 1YF

UK

WEBSITE: [www.drapertools.com](http://www.drapertools.com)

PRODUCT HELPLINE: +44 (0) 23 8049 4344

GENERAL FAX: +44 (0) 23 8026 0784

## **1.3 UNDERSTANDING THIS MANUALS SAFETY CONTENT:**

**WARNING!** Information that draws attention to the risk of injury or death.

**CAUTION!** Information that draws attention to the risk of damage to the product or surroundings.

## **1.4 COPYRIGHT © NOTICE:**

Copyright © Draper Tools Limited.

Permission is granted to reproduce this publication for personal & educational use only.

Commercial copying, redistribution, hiring or lending is prohibited.

No part of this publication may be stored in a retrieval system or transmitted in any other form or means without written permission from Draper Tools Limited.

In all cases this copyright notice must remain intact.

## 2. CONTENTS

---

### 2.1 CONTENTS

		<i>Page</i>
1	TITLE PAGE	
	1.1 INTRODUCTION .....	2
	1.2 REVISION HISTORY .....	2
	1.3 UNDERSTANDING THIS MANUAL .....	2
	1.4 COPYRIGHT NOTICE .....	2
2	CONTENTS	
	2.1 CONTENTS .....	3
3	GUARANTEE	
	3.1 GUARANTEE .....	4
4	INTRODUCTION	
	4.1 SCOPE .....	5
	4.2 SPECIFICATION .....	5
	4.3 HANDLING & STORAGE .....	5
5	HEALTH & SAFETY INFORMATION	
	5.1 GENERAL SAFETY INSTRUCTIONS FOR TROLLEY JACK .....	6-7
6	TECHNICAL DESCRIPTION	
	6.1 IDENTIFICATION .....	8
7	UNPACKING & CHECKING	
	7.1 PACKAGING .....	9
	7.2 WHAT'S IN THE BOX? .....	9
8	ASSEMBLY	
	8.1 ASSEMBLY .....	10
9	OPERATING THE TROLLEY JACK	
	9.1 BEFORE USE .....	11
	9.2 RAISE AND LOWER JACK .....	11
10	MAINTENANCE	
	10.1 LUBRICATION .....	12
	10.2 DECOMMISSIONING THE JACK .....	12
11	OPTIONAL ACCESSORIES	
	11.1 OPTIONAL ACCESSORIES .....	13
12	TROUBLESHOOTING	
	12.1 TROUBLESHOOTING .....	14
	DECLARATION OF CONFORMITY .....	ENCLOSED

## 3. GUARANTEE

---

### 3.1 GUARANTEE

Draper tools have been carefully tested and inspected before shipment and are guaranteed to be free from defective materials and workmanship.

Should the tool develop a fault, please return the complete tool to your nearest distributor or contact Draper Tools Limited, Chandler's Ford, Eastleigh, Hampshire, SO53 1YF. England.

Telephone Sales Desk: (023) 8049 4333 or Product Helpline (023) 8049 4344.

A proof of purchase must be provided with the tool.

If upon inspection it is found that the fault occurring is due to defective materials or workmanship, repairs will be carried out free of charge. This guarantee period covering parts/labour is 12 months from the date of purchase except where tools are hired out when the guarantee period is ninety days from the date of purchase. This guarantee does not apply to normal wear and tear, nor does it cover any damage caused by misuse, careless or unsafe handling, alterations, accidents, or repairs attempted or made by any personnel other than the authorised Draper warranty repair agent.

Note: If the tool is found not to be within the terms of warranty, repairs and carriage charges will be quoted and made accordingly.

This guarantee applies in lieu of any other guarantee expressed or implied and variations of its terms are not authorised.

Your Draper guarantee is not effective unless you can produce upon request a dated receipt or invoice to verify your proof of purchase within the guarantee period.

Please note that this guarantee is an additional benefit and does not affect your statutory rights.

Draper Tools Limited.

## 4. INTRODUCTION

---

### 4.1 SCOPE

This jack is designed for heavy duty garage/workshop use. To lift vehicles to the maximum stated weight limit.

### 4.2 SPECIFICATION

Stock no .....	53089 .....	60977
Part no .....	TJ3HD/B .....	TJ3HD/BR
Capacity .....	3000kg .....	3000kg
Lifting range .....	145-520mm .....	145-520mm
Overall size (LxWxH) .....	720x345x185mm .....	720x345x185mm
Weight .....	36.7kg .....	36.7kg

### 4.3 HANDLING & STORAGE

The environment will have a negative result on its operation if you are not careful. If the air is damp, components will rust. If the machine is unprotected from dust and debris; components will become clogged: And if not cleaned and maintained correctly or regularly the machine will not perform at its best.

## 5. HEALTH & SAFETY INFORMATION

---

### 5.1 GENERAL SAFETY INSTRUCTION FOR TROLLEY JACK

- The vehicle to be lifted should never exceed the rated capacity of the jack.
- The maximum stroke of the jack should never be exceeded.
- The jack should be supported on a solid, level and horizontal surface which is well illuminated and free of obstructions. Never stand the jack on a surface which may sink. Ensure that there are no persons inside the vehicle to be lifted. Switch off the engine and apply the brake. Ensure the vehicle or element to be lifted against any type of sliding. Use chocks if appropriate. Do not enter the vehicle or start the engine whilst it is supported on the jack or appropriate stands. The jack is a lifting device only and should never be used to move the vehicle.
- Position the jack under the vehicle manufacturer's recommended lifting point for the vehicle and ensure that it is not corroded, dirty or greasy. This point should remain centred over the jack saddle. Off-centred loads can slip and accidents may result.
- During raising and lowering of the load, all precautions should be taken to avoid movement of the vehicle load. Traffic may cause the raised vehicle to rock during roadside use of the jack.
- The jack should be positioned so as to avoid the need for the user to introduce any part of his/her body underneath the vehicle. Never work under a raised vehicle without supporting it with axle stands or other appropriate methods. Never position any part of your body near the movable elements of the jack.
- It is necessary for the operator to be able to observe the lifting device and the load during all movements. In the presence of dangerous conditions, such as movement of the vehicle, etc, the lifting process must be interrupted.
- Ensure that there are no persons or obstructions underneath the vehicle prior to lowering.
- As an additional safety measure against overload, the jack is fitted with an overload valve set at the factory and which should not be adjusted under any circumstances. If the capacity of the jack is exceeded, the overload valve will stop the lifting operation.

#### CAUTION:

- Use only on a firm, level surface.
- Do not exceed the rated capacity of this jack.
- This is a lifting device only ... do not work under the vehicle without proper support devices, such as axle stands.
- Make sure that the lifting point is stable and correctly centred on the jack saddle.
- Familiarize yourself thoroughly with this manual before operating to prevent damage to the jack, property, or personal injury.

## 5. HEALTH & SAFETY INFORMATION

---

### 1 - BEFORE POSITIONING THE JACK, YOU SHOULD ENSURE THE FOLLOWING:

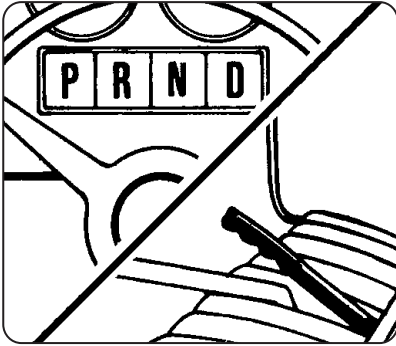

- i. Vehicle should be clear of all passengers. Transmission should be in gear (or 'Park' for automatic transmissions) and the handbrake applied.

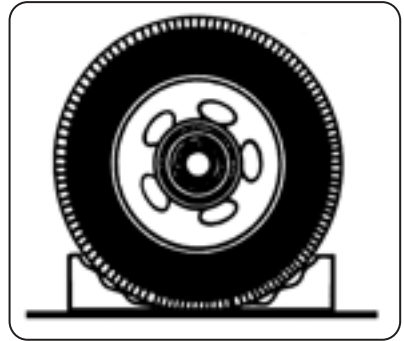

- ii. To prevent vehicle from movement, wheels should be securely blocked with wheel chocks (Draper Stock No.54500).

### 2 - CORRECT POSITIONING:

The jack should be positioned under the approved lifting points for the vehicle. Since these points may vary with each vehicle, it is important to refer to the vehicle manufacturer's or Haynes workshop manuals.

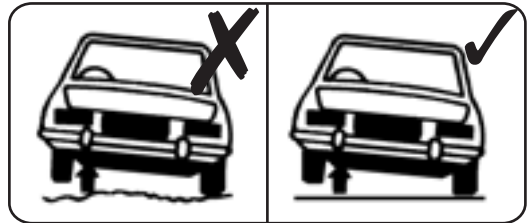

### 3 - TERRAIN:

The jack should be operated on a hard and level surface as the location will permit.

### 4 - NEVER EXCEED THE JACK'S RATED CAPACITY.

### 5 - WORKING UNDER THE VEHICLE:

It is extremely important, when working under the vehicle, to ensure axle stands are always used.

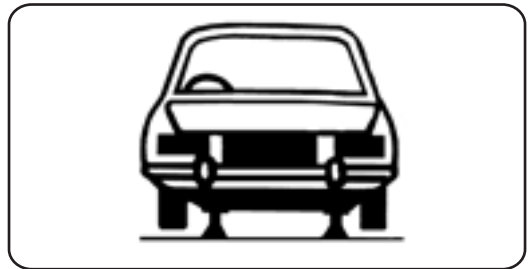

## 6. TECHNICAL DESCRIPTION

---

### 6.1 IDENTIFICATION

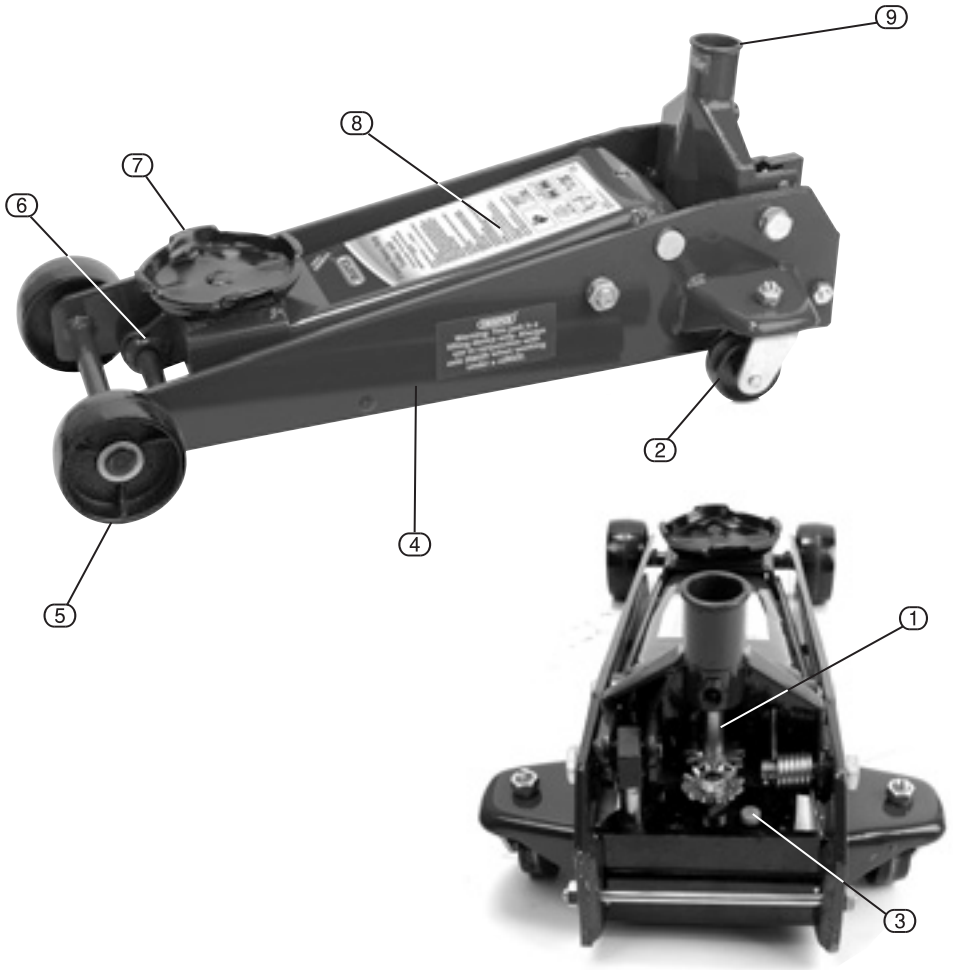

① Cylinder Pump.

② Rear castor.

③ Safety overload valve.

④ Frame.

⑤ Front Wheel.

⑥ Radius Link.

⑦ Saddle.

⑧ Lifting Arm.

⑨ Handle Sleeve.



# 7. UNPACKING & CHECKING

---

## 7.1 PACKAGING

Carefully remove the Trolley Jack from the packaging and examine it for any sign of damage that may have happened during shipping. Lay the contents out and check them against the parts shown below. If any part is damaged or missing; please contact the Draper Helpline (the telephone number appears on the Title page) and do not attempt to use the jack.

The packaging material should be retained at least during the guarantee period: in case the machine needs to be returned for repair.

Warning! Some of the packaging materials used may be harmful to children. Do not leave any of these materials in the reach of children.

If any of the packaging is to be thrown away, make sure they are disposed of correctly; according to local regulations.

## 7.2 WHAT'S IN THE BOX?

As well as the trolley jack; there are several parts not fitted or attached to it.



⑪ Jack handle.

⑫ Jack handle assembly bolts.

## 8. ASSEMBLY

---

### 8.1 ASSEMBLY FIGS 1 - 2

Locate the upper and lower part of handles (11) together and secure in place with bolt (12) provided.

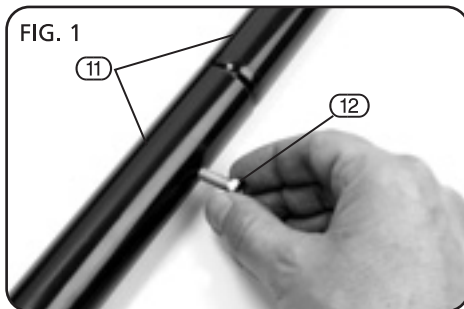

Locate the bottom part of assembled handle into the handle sleeve and retain in place by tightening bolt (12) provided.

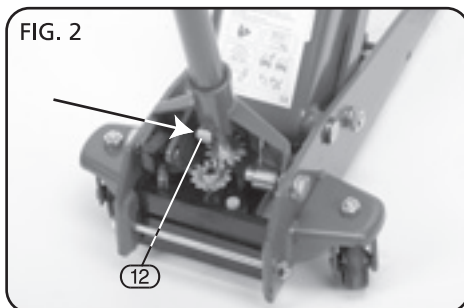

## 9. OPERATING THE TROLLEY JACK

### 9.1 BEFORE USE FIG. 3

1. If oil spillage is noted, check oil level, refer to "Maintenance" section.  
NOTE: Jack must be bled before use to ensure any air is expelled from the pump unit before use.
2. To bleed jack before use check to see that the release valve is opened by turning pump handle anti-clockwise. (Never more than two full turns anti-clockwise), pump 5 - 10 full strokes to purge any air from the system and evenly distribute the hydraulic oil.
3. Tighten release valve.
4. Check jack lifts and lowers smoothly before use.

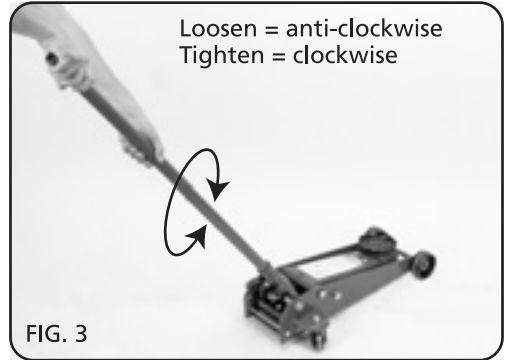

### 9.2 RAISE AND LOWER JACK Fig. 4

Check that the saddle is correctly positioned.  
TO RAISE LOAD

Twist handle in clockwise direction, then pump up and down fully, until the desired height is reached.

ALWAYS USE AXLE STANDS.

TO LOWER LOAD

Slowly twist the handle anti-clockwise up to two full turns, lowering the load slowly and controlled.

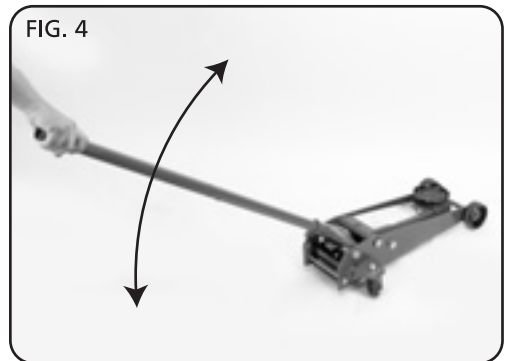

# 10. MAINTENANCE

---

## 10.1 LUBRICATION *Fig. 1*

- i. When the jack is not in use, the lifting arm and handle sleeve should be kept in the fully down position.
  - ii. Keep the jack clean and lubricated. Lubricate the points indicated on the diagram on a regular basis.
  - iii. To check oil level, fully lower jack on level ground. Remove filler plug. The correct level is 5mm below filler plug hole. If low, add oil as needed. **YOUR JACK WAS FILLED AT THE FACTORY WITH HIGH GRADE HYDRAULIC OIL. ONLY USE APPROVED JACK OIL\*.**
  - iv. After extensive use, the oil supply should be replaced to ensure longer equipment life. To drain, remove filler plug and release valve. Ensure that no dirt gets into the system. Refill with approved jack oil\*.
  - v. Check pump piston rod periodically for signs of rust or corrosion. Clean exposed area with a clean oiled cloth.
- \* We recommend Draper stock no.34053 or 34054 hydraulic oil.

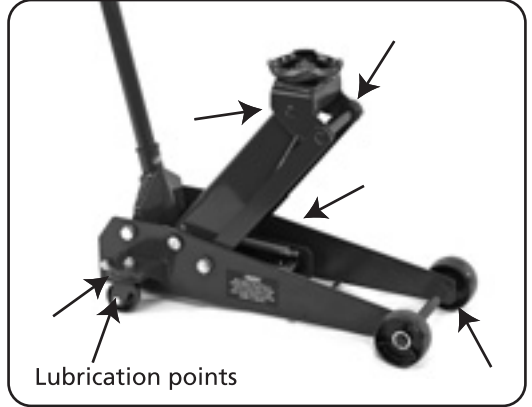

## 10.2 DECOMMISSIONING THE JACK

When the jack has reached the end of its working life and requires disposal. Draw off the oil into a suitable container and dispose of the jack and oil according to local regulations.

# 11. OPTIONAL ACCESSORIES

---

## 11.1 OPTIONAL ACCESSORIES

STOCK No.	PART No.	DESCRIPTION
30881	AS3000R	Axle Stands
54500	RWC	Wheel Chocks

# 12. TROUBLESHOOTING

## 12.1 TROUBLESHOOTING

PROBLEM	POSSIBLE CAUSE	REQUIRED ACTION
Jack will not hold load.	Oil control valves not seating.	<ol style="list-style-type: none"><li>1. Lower the lifting arm, close the release valve and remove oil filler plug.</li><li>2. Place one foot on a front wheel and pull the lifting arm up to its full height by hand.</li><li>3. Open the release valve to lower the lifting arm.</li></ol>
Jack will not lift load. Jack will not lift to its full height. Jack pump feels unsteady under load. Jack will not lower completely.	Air block.	<ol style="list-style-type: none"><li>1. Open the release valve and remove oil filler plug.</li><li>2. Pump handle 5 - 10 full strokes and close the release valve.</li></ol>
Jack will not lift to its full height. Jack pump feels unsteady under load.	The reservoir could be overfilled. Low hydraulic oil level.	Check the oil level. Remove the filler plug, adjust to correct level.
Jack pump feels unsteady under load.	The pump cup seal could be worn out.	Replace the cup seal with a new one.
Jack will not lower completely.	Air block. Unit needs lubrication.	Release air by removing filler plug. Lubricate external moving parts.

**IMPORTANT:** Please note all repairs/service should be carried out by a qualified person.



- **DRAPER TOOLS LIMITED,**  
Hursley Road, Chandler's Ford,  
Eastleigh, Hampshire. SO53 1YF. U.K.
  
- **Helpline:** (023) 8049 4344
- **Sales Desk:** (023) 8049 4333
- **Website:** [www.drapertools.com](http://www.drapertools.com)
- **E-mail:** [sales@drapertools.com](mailto:sales@drapertools.com)
- **Sales Fax:** (023) 8049 4209
- **General Enquiries:** (023) 8026 6355
  
- **Service/Warranty Repair Agent**  
For aftersales servicing or warranty repairs, please  
contact the Draper Tools Helpline for details of an  
agent in your local area.

YOUR DRAPER STOCKIST