

DRAPER[®]

230V

LAWN AERATOR/SCARIFIER

97921/98931, 97922

UK
CA CE

Stock No.97921/98931



Stock No.97922

These instructions accompanying the product are the original instructions. This document is part of the product, keep it for the life of the product passing it on to any subsequent holder of the product. Read all these instructions before assembling, operating or maintaining this product.

This manual has been compiled by Draper Tools describing the purpose for which the product has been designed, and contains all the necessary information to ensure its correct and safe use. By following all the general safety instructions contained in this manual, it will ensure both product and operator safety, together with longer life of the product itself.

All photographs and drawings in this manual are supplied by Draper Tools to help illustrate the operation of the product.

Whilst every effort has been made to ensure the accuracy of information contained in this manual, the Draper Tools policy of continuous improvement determines the right to make modifications without prior warning.

1. TITLE PAGE

1.1 INTRODUCTION:

USER MANUAL FOR: 230V Lawn Aerator/Scarifier

Stock No's: 97921/98931, 97922

Part No's: GLAS1500D/GLAS1500D/AUS, GLAS1800D

1.2 REVISIONS:

Date first published March 2021.

Date first revision October 2023.

As our user manuals are continually updated, users should make sure that they use the very latest version.

Downloads are available from: <http://drapertools.com/manuals>

Draper Tools Limited
Hursley Road
Chandler's Ford
Eastleigh
Hampshire
SO53 1YF
UK

Delta International
Delta International BV
Oude Graaf 8
6002 NL
Weert
Netherlands

Website: drapertools.com

Product Help Line: +44 (0) 23 8049 4344

General Fax: +44 (0) 23 8026 0784

1.3 UNDERSTANDING THIS MANUALS SAFETY CONTENT:

Warning! – Information that draws attention to the risk of injury or death.

Important – Information that draws attention to the risk of damage to the product or surroundings.

1.4 COPYRIGHT © NOTICE:

Copyright © Draper Tools Limited.

Permission is granted to reproduce this publication for personal and educational use only. Commercial copying, redistribution, hiring or lending is prohibited.

No part of this publication may be stored in a retrieval system or transmitted in any other form or means without written permission from Draper Tools Limited.

In all cases this copyright notice must remain intact.

2. CONTENTS

2.1 TABLE OF CONTENTS

1. TITLE PAGE

| | | |
|-----|---|---|
| 1.1 | INTRODUCTION:..... | 2 |
| 1.2 | REVISIONS:..... | 2 |
| 1.3 | UNDERSTANDING THIS MANUALS SAFETY CONTENT:..... | 2 |
| 1.4 | COPYRIGHT © NOTICE:..... | 2 |

2. CONTENTS

| | | |
|-----|-------------------------|---|
| 2.1 | TABLE OF CONTENTS | 3 |
|-----|-------------------------|---|

3. WARRANTY

| | | |
|-----|---------------|---|
| 3.1 | WARRANTY..... | 4 |
|-----|---------------|---|

4. INTRODUCTION

| | | |
|-----|---------------------------|---|
| 4.1 | SCOPE..... | 5 |
| 4.2 | SPECIFICATION..... | 5 |
| 4.3 | HANDLING AND STORAGE..... | 5 |

5. HEALTH AND SAFETY INFORMATION

| | | |
|-----|--|---|
| 5.1 | GENERAL SAFETY INSTRUCTIONS FOR POWER TOOL USE | 6 |
| 5.2 | ADDITIONAL SAFETY INSTRUCTIONS FOR LAWN AERATOR/SCARIFIER..... | 7 |
| 5.3 | RESIDUAL RISK..... | 8 |
| 5.4 | CONNECTION TO THE POWER SUPPLY | 8 |

6. TECHNICAL DESCRIPTION

| | | |
|-----|---------------------|----|
| 6.1 | IDENTIFICATION..... | 10 |
|-----|---------------------|----|

7. UNPACKING AND CHECKING

| | | |
|-----|-------------------------|----|
| 7.1 | PACKAGING | 11 |
| 7.2 | WHAT'S IN THE BOX | 11 |

8. PREPARING THE LAWN AERATOR/SCARIFIER

| | | |
|-----|--|----|
| 8.1 | CABLE RESTRAINT (97921/98931)..... | 12 |
| 8.2 | HANDLE ASSEMBLY (97921/98931) | 12 |
| 8.3 | CABLE RESTRAINT (97922)..... | 14 |
| 8.4 | HANDLE ASSEMBLY (97922) | 14 |
| 8.5 | ASSEMBLING THE COLLECTION BAG | 17 |
| 8.6 | INSERTING THE AERATOR/SCARIFIER CARTRIDGES (97921/98931) | 18 |
| 8.7 | INSERTING THE AERATOR/SCARIFIER CARTRIDGES (97922) | 19 |

9. OPERATION

| | | |
|-----|---------------------------|----|
| 9.1 | WORKING HEIGHT | 20 |
| 9.2 | SWITCHING ON AND OFF..... | 20 |

10. MAINTENANCE AND TROUBLESHOOTING

| | | |
|------|----------------------------|----|
| 10.1 | MAINTENANCE | 21 |
| 10.2 | TROUBLESHOOTING GUIDE..... | 21 |

11. DISPOSAL

| | | |
|------|----------------|----|
| 11.1 | DISPOSAL | 22 |
|------|----------------|----|

12. EXPLANATION OF SYMBOLS

| | | |
|------|-----------------------------|----|
| 12.1 | EXPLANATION OF SYMBOLS..... | 23 |
|------|-----------------------------|----|

3. WARRANTY

3.1 WARRANTY

Draper tools have been carefully tested and inspected before shipment and are guaranteed to be free from defective materials and workmanship.

Should the tool develop a fault, please return the complete tool to your nearest distributor or contact:

Draper Tools Limited, Chandler's Ford, Eastleigh, Hampshire, SO53 1YF. England.

Telephone Sales Desk: +44 (0) 8049 4333 or Product Help Line +44 (0) 23 8049 4344.

A proof of purchase **must** be provided with the tool.

If upon inspection it is found that the fault occurring is due to defective materials or workmanship, repairs will be carried out free of charge. This warranty period covering parts/labour is 12 months from the date of purchase except where tools are hired out when the warranty period is 90 days from the date of purchase. This warranty does not apply to any consumable parts, any type of battery or normal wear and tear, nor does it cover any damage caused by misuse, careless or unsafe handling, alterations, accidents, or repairs attempted or made by any personnel other than the authorised Draper warranty repair agent.

Note: If the tool is found not to be within the terms of warranty, repairs and carriage charges will be quoted and made accordingly.

This warranty applies in lieu of any other warranty expressed or implied and variations of its terms are not authorised.

Your Draper warranty is not effective unless you can produce upon request a dated receipt or invoice to verify your proof of purchase within the warranty period.

Please note that this warranty is an additional benefit and does not affect your statutory rights.

Draper Tools Limited.

4. INTRODUCTION

4.1 SCOPE

This lawn aerator/scarifier is designed to perforate lawns and remove harmful lawn thatch. As part of our core range, this product is suitable for enthusiasts and tradespeople alike. Any other application is considered misuse.

4.2 SPECIFICATION

| | | |
|-----------------------------------|----------------------------------|--------------------------------|
| Stock No. | 97921/98931 | 97922 |
| Part No. | GLAS1500D / GLAS1500D/AUS | GLAS1800D |
| Rated voltage: | 230V~50Hz..... | 230V~50Hz |
| Rated input: | 1500W..... | 1800W |
| Speed (no load): | 3,000r/min..... | 3,500r/min |
| Working width: | 320mm | 380mm |
| Working depth: | 4 positions: -12/-8/-4/+4mm..... | 5 positions: -12/-9/-6/-3/+6mm |
| Scarifying cartridge:..... | 16 blades | 16 blades |
| Aerator cartridge:..... | 20 tines | 24 tines |
| Sound pressure level (LpA): | 84.5dB(A)..... | 90.2dB(A) |
| Sound power level (LWA): | 97.3dB(A) | 105.17dB(A) |
| Uncertainty (K): | 3dB(A) | 3dB(A) |
| Max. vibration level:..... | 4.27m/s ² | 1.679m/s ² |
| Uncertainty (K): | 1.5m/s ² | 1.5m/s ² |
| Power supply cable length:..... | 10M/0.35M..... | 10M |
| Collection bag capacity:..... | 30L..... | 45L |
| Ingress protection class:..... | IPX4..... | IPX4 |
| Weight: | 9.3kg | 14kg |

4.3 HANDLING AND STORAGE

- Care must be taken when handling this product. Dropping this power tool could have an effect on its accuracy and could also result in personal injury. This product is not a toy and must be respected.
- Environmental conditions can have a detrimental effect on this product if neglected. Exposure to damp air can gradually corrode components. If the product is unprotected from dust and debris, components will become clogged. If not cleaned and maintained correctly or regularly, the machine will not perform at its best.

5. HEALTH AND SAFETY INFORMATION

5.1 GENERAL SAFETY INSTRUCTIONS FOR POWER TOOL USE

When using any type of power tool there are steps that should be taken to make sure that you, as the user, remain safe.

Common sense and a respect for the tool will help reduce the risk of injury.

Read the instruction manual fully. Do not attempt any operation until you have read and understood this manual.

Most important you must know how to safely start and stop this machine, especially in an emergency.

Keep the work area tidy and clean. Attempting to clear clutter from around the machine during use will reduce your concentration. Mess on the floor creates a trip hazard. Any liquid spilt on the floor could result in you slipping.

Find a suitable location. If the machine is bench mounted, the location should provide good natural light or artificial lighting as a replacement. Avoid damp and dust locations as it will have a negative effect on the machine's performance. If the machine is portable do not expose the tool to rain. In all cases do not operate power tools near any flammable materials.

Keep bystanders away. Children, onlookers and passers by must be restricted from entering the work area for their own protection. The barrier must extend a suitable distance from the tool user.

Unplug and house all power tools that are not in use. A power tool should never be left unattended while connected to the power supply. They must be housed in a suitable location, away locked up and from children. This includes battery chargers.

Do not overload or misuse the tool. All tools are designed for a purpose and are limited to what they are capable of doing. Do not attempt to use a power tool (or adapt it in any way) for an application it is not designed for. Select a tool appropriate for the size of the job. Overloading a tool will result in tool failure and user injury. This covers the use of accessories.

Dress properly. Loose clothing, long hair and jewellery are all dangerous because they can become entangled in moving machinery. This can also result in parts of body being pulled into the machine. Clothing should be close fitted, with any long hair tied back and jewellery and neck ties removed. Footwear must be fully enclosed and have a non-slip sole.

Wear personal protective equipment (PPE). Dust, noise, vibration and swarf can all be dangerous if not suitably protected against. If the work involving the power tool creates dust or fumes wear a dust mask. Vibration to the hand, caused by operating some tools for longer periods must be protected against. Wear vibration reducing gloves and allow long breaks between uses. Protect against dust and swarf by wearing approved safety goggles or a face shield. These are some of the more common hazards and preventions, however, always find out what hazards are associated with the machine/work process and wear the most suitable protective equipment available.

Do not breathe contaminated air. If the work creates dust or fumes connect the machine (if possible) to an extraction system either locally or remotely. Working outdoors can also help if possible.

Move the machine as instructed. If the machine is hand held, do not carry it by the power supply cable. If the product is heavy, employ a second or third person to help move it safely or use a mechanical device. Always refer to the instructions for the correct method.

Do not overreach. Extending your body too far can result in a loss of balance and you falling. This could be from a height or onto a machine and will result in injury.

Maintain your tools correctly. A well maintained tool will do the job safely. Replace any damaged or missing parts immediately with original parts from the manufacturer. As applicable, keep blades sharp, moving parts clean, oiled or greased, handles clean, and emergency devices working.

5. HEALTH AND SAFETY INFORMATION

Wait for the machine to stop. Unless the machine is fitted with a safety brake, some parts may continue to move due to momentum. Wait for all parts to stop, then unplug it from the power supply before making any adjustments, carrying out maintenance operations or just finishing using the tool.

Remove and check setting tools. Some machinery requires the use of additional tools or keys to set, load or adjust the power tool. Before starting the power tool always check to make certain they have been removed and are safely away from the machine.

Prevent unintentional starting. Before plugging any machine in to the power supply, make sure the switch is in the OFF position. If the machine is portable, do not hold the machine near the switch and take care when putting the machine down, that nothing can operate the switch.

Carefully select an extension lead. Some machines are not suitable for use with extension leads. If the tool is designed for use outdoors, use an extension lead also suitable for that environment. When using an extended lead, select one capable of handling the current (amps) drawn by the machine in use. Fully extend the lead regardless of the distance between the power supply and the tool. Excess current (amps) and a coiled extension lead will both cause the cable to heat up and can result in fire.

Concentrate and stay alert. Distractions are likely to cause an accident. Never operate a power tool if you are under the influence of drugs (prescription or otherwise), including alcohol or if you are feeling tired. Being disorientated will result in an accident.

Have this tool repaired by a qualified person. This tool is designed to conform to the relevant international and local standards and as such should be maintained and repaired by someone qualified, using only original parts supplied by the manufacturer. This will ensure the tool remains safe to use.

5.2 ADDITIONAL SAFETY INSTRUCTIONS FOR LAWN AERATOR/ SCARIFIER

Important: Draper Tools Limited recommends that this machine should not be modified or used for any application other than that for which it was designed. If you are unsure of its relative applications do not hesitate to contact us in writing and we will advise you.

Training. Read the instructions carefully. Be familiar with the controls and the proper use of the machine.

Preparation. Never allow people unfamiliar with these instructions or children to use the machine. Local regulations can restrict the age of the operator.

- Never operate the machine while people, especially children, or pets are nearby.
- Keep in mind that the operator or user is responsible for accidents or hazards occurring to other people or their property.
- Wear ear protection and safety glasses at all times while operating the machine.
- While operating the machine, always wear substantial footwear and long trousers. Do not operate the machine when barefoot or wearing open sandals.
- Thoroughly inspect the area where the machine is to be used and remove all stones, sticks, wires and other foreign objects.
- Before using, always visually inspect to see that the tines, bolts are not worn or damaged. Replace worn or damaged tines and bolts in sets to preserve balance.

Operation. Operate the machine only in daylight or in good artificial light.

- Avoid operating the machine in wet grass or take additional precautions to avoid slipping.
- Always be sure of your footing on slopes.
- Walk, never run.
- Always work across the face of slopes, never up and down.
- Exercise extreme caution when changing direction on slopes.

5. HEALTH AND SAFETY INFORMATION

- Do not operate the machine on steep slopes.
- Use extreme caution when reversing or pulling the machine towards you.
- Stop the tines if the machine has to be tilted for transportation. Do not operate the tines when crossing surfaces other than grass, and when transporting the machine to and from the working area.
- Never operate the machine with defective guards, or without safety devices, for example deflectors and/or catchers, in place.
- Switch on the motor carefully according to instructions and with feet well away from the tines.
- Do not tilt the machine when switching on the motor, except if the machine has to be tilted for starting. In this case, do not tilt it more than absolutely necessary and lift only the part which is away from the operator.
- Do not start the motor when standing in front of the discharge chute.
- Do not put hands or feet near or under rotating parts. Keep clear of the discharge opening at all times.
- Never pick up or carry a machine while the motor is running.
- Disconnect the plug from the mains:
 - Before clearing blockages or unclogging chute.
 - Before checking, cleaning or working on the machine.
 - After striking a foreign object. Inspect the machine for damage and make repairs before restarting and operating the machine.
 - If the machine starts to vibrate abnormally (check immediately).
 - Whenever you leave the machine.

Maintenance & Storage. Keep all nuts, bolts and screws tight to be sure the machine is in a safe working condition.

- Check the catcher frequently for wear or deterioration.
- Examine the machine regularly and replace worn or damaged parts for safety.

5.3 RESIDUAL RISK

Important: Although the safety instructions and operating manuals for our tools contain extensive instructions of safe working with power tools, every power tool involves a certain residual risk which can not be completely excluded by safety mechanisms. Power tools must therefore always be operated with caution!

5.4 CONNECTION TO THE POWER SUPPLY

Caution: Risk of electric shock. Do not open.

This appliance is supplied with an approved plug and cable for your safety.

If a replacement plug is to be fitted this must be carried out by a qualified electrician.

The damaged or incomplete plug, when cut from the cable should be disabled to prevent connection to a live electrical outlet.

This appliance is Class II† and is designed for connection to a power supply matching that detailed on the rating label and compatible with the plug fitted.

If an extension lead is required, use an approved and compatible lead rated for this appliance. Follow all the instructions supplied with the extension lead.

†*Double insulated* : This product requires no earth connection as supplementary insulation is applied to the basic insulation to protect against electric shock in the event of failure of the basic insulation.

5. HEALTH AND SAFETY INFORMATION

IMPORTANT

If using an extension lead, follow the instructions that came with your lead regarding maximum load while cable is wound. If in doubt, ensure that the entire cable is unwound. Using a coiled extension lead will generate heat which could melt the lead and cause a fire.

6. TECHNICAL DESCRIPTION

6.1 IDENTIFICATION

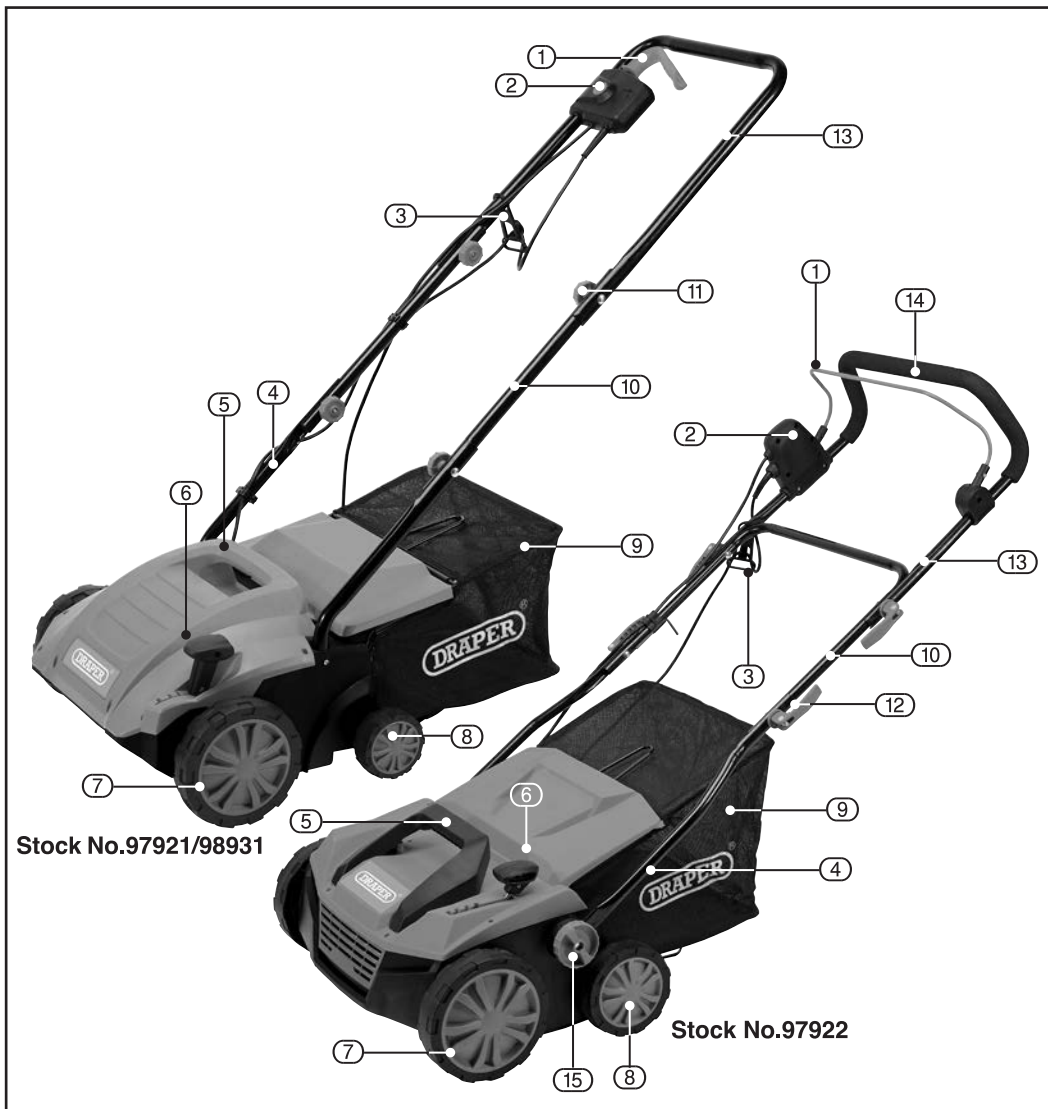

- | | |
|-------------------------------|----------------------------------|
| ① ON/OFF lever switch. | ⑨ Collection bag. |
| ② Safety button. | ⑩ Middle handle section. |
| ③ Cable restraint. | ⑪ Handle locks (97921/98931). |
| ④ Lower handle sections. | ⑫ Handle locks (97922). |
| ⑤ Motor unit carry handle. | ⑬ Upper handle section. |
| ⑥ Variable height adjustment. | ⑭ Soft handle grip (97922 only). |
| ⑦ Front wheels. | ⑮ Lower handle clamps (97922). |
| ⑧ Rear wheels. | |

7. UNPACKING AND CHECKING

7.1 PACKAGING

Carefully remove the product from the packaging and examine it for any sign of damage that may have happened during shipping. Lay the contents out and check them against the parts shown below. If any part is damaged or missing, please contact the Draper Help Line (the telephone number appears on the Title page) and do not attempt to use the product.

The packaging material should be retained at least during the warranty period, in case the machine needs to be returned for repair.

Warning!

- Some of the packaging materials used may be harmful to children. Do not leave any of these materials in the reach of children.
- If any of the packaging is to be thrown away, make sure they are disposed of correctly, according to local regulations.

7.2 WHAT'S IN THE BOX

As well as the main product, there are several parts not fitted or attached to it.

Note: For details of our full range of accessories and consumables, please visit drapertools.com

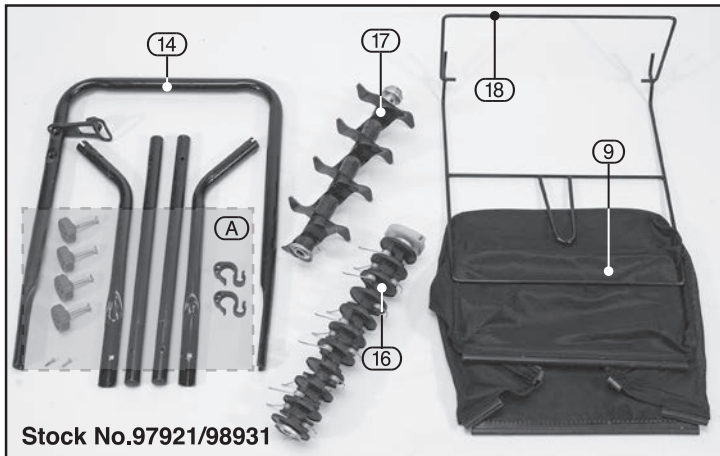

- (9) Collection bag.
- (11) Handle locks.
- (16) Scarifier cartridge.
- (17) Aerator cartridge.
- (18) Collection bag frame.
- (19) Cable clips.
- (20) Lower handle fittings.

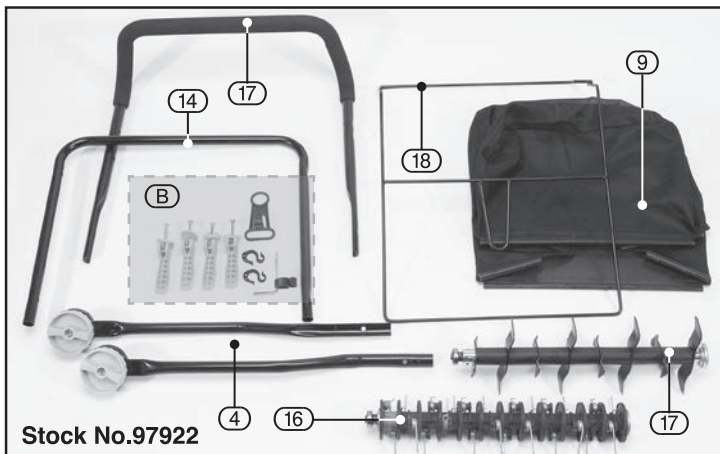
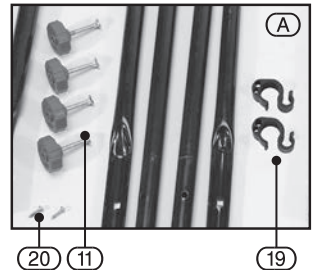

- (9) Collection bag.
- (12) Handle locks.
- (16) Scarifier cartridge.
- (17) Aerator cartridge.
- (18) Collection bag frame.
- (19) Cable clips.
- (21) Hex. key.

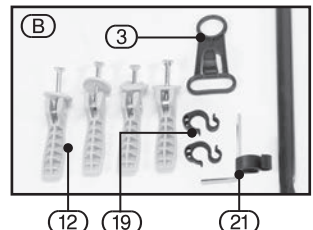

8. PREPARING THE LAWN AERATOR/SCARIFIER

8.1 CABLE RESTRAINT (97921/98931) – FIG. 1

Before assembling the handle sections, slide the cable restraint (3) over the upper handle section (13).

This is an important safety device, it prevents pressure being put onto the cable connections.

Never operate the product without the cable restraint.

8.2 HANDLE ASSEMBLY (97921/98931) – FIGS. 2 – 8

Warning! Remove the plug from the socket before carrying out adjustment, servicing or maintenance.

- Slot the handle lower sections (4) into holes located on body and secure with screws (20) provided, Fig.1.
- Assemble the handle mid section (10) over the outside of the lower handles (4) so the concave face of the handle is innermost.
- Push bolts (11.1) inward through the mid section (locating the square shoulder) and through the lower section handle before securing with locking knob (11.2) Fig.2.
- The top section (13) of the handle is secured the same method as the mid section (10).

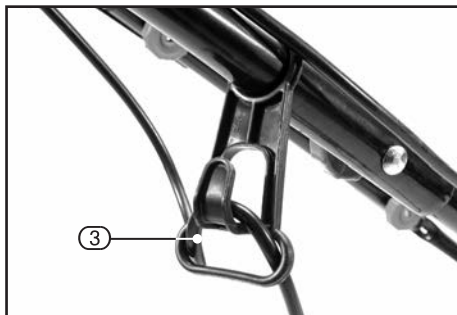

FIG.1

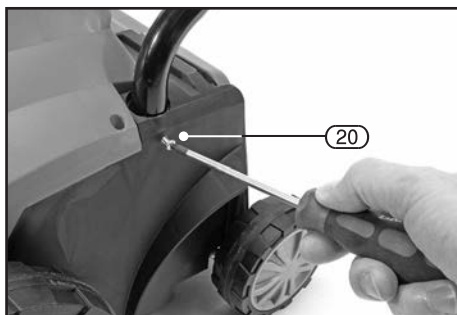

FIG.2

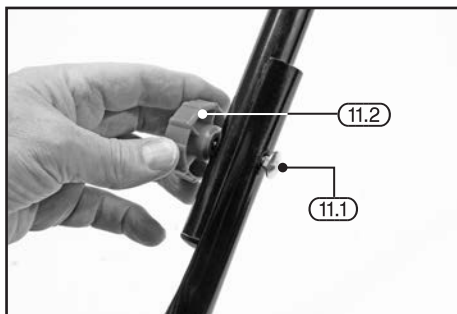

FIG.3



FIG.4

8. PREPARING THE LAWN AERATOR/SCARIFIER

- Loosen the screws in the back of the ON/OFF trigger switch control unit (1) and separate the 2 halves.
- Locate both halves with the 2 screw holes over the upper handle assembly.
- Re-fit the screws to fasten the unit in place on the handle section.
- Fasten loose cables to the assembled handle sections using the cable clips (19)

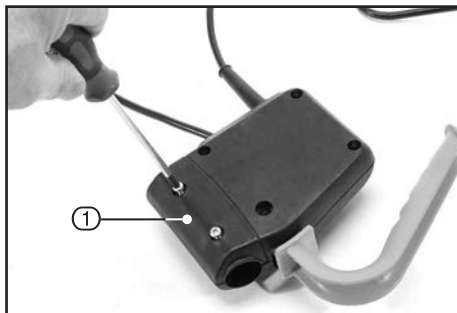

FIG.5



FIG.6



FIG.7



FIG.8

8. PREPARING THE LAWN AERATOR/SCARIFIER

8.3 CABLE RESTRAINT (97922) – FIG. 9

Before assembling the handle sections, slide the cable restraint (3) over the upper handle section (13).

This is an important safety device, it prevents pressure being put onto the cable connections. Never operate the product without the cable restraint

8.4 HANDLE ASSEMBLY (97922) FIGS. 10 – 19

Warning! Remove the plug from the socket before carrying out adjustment, servicing or maintenance.

- Attach each of the lower handle sections by locating the fittings (15) with the holes on each side of the base unit.
- Tighten the fittings to secure in place.
- Connect the middle handle sections (10) using the handle locks (12).
- Slide the bolt (12.1) through the hole joining the two sections. A concave sided washer (12.2) must be placed on the inner side of the handle assembly.
- Thread the locks (12) over the bolts. When tightened, the locks can be snapped down to secure the assembled sections in place.
- The top section (13) of the handle is secured the same method as the mid section (10)



FIG.9

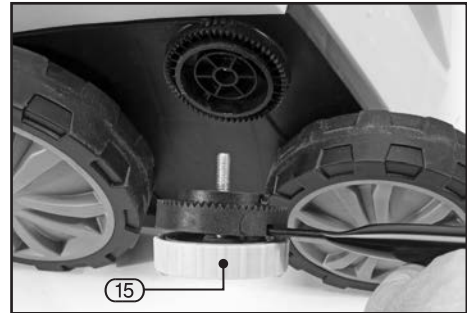

FIG.10

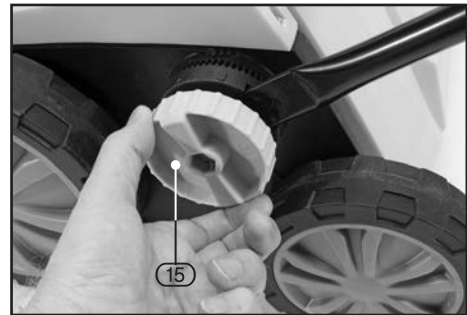

FIG.11

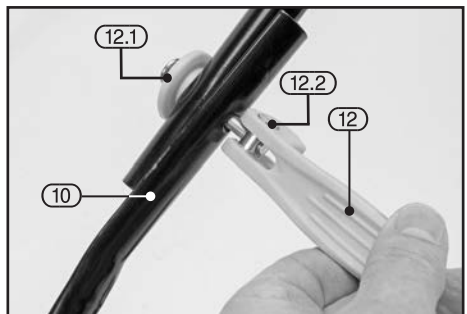

FIG.12

8. PREPARING THE LAWN AERATOR/SCARIFIER

- Loosen the screws in both parts of the ON/OFF trigger switch control unit ① / ①.1 and separate the component parts.
- Locate control unit with the holes the upper handle assembly (fig.14).
- Re-fit the screws to fasten the unit in place on the upper handle section.



FIG.13

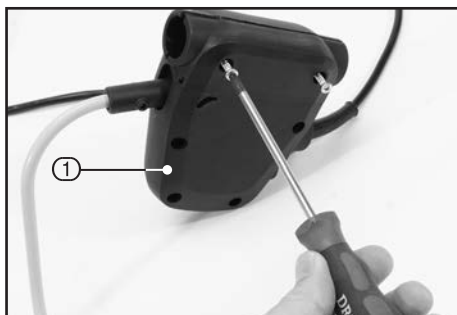

FIG.14

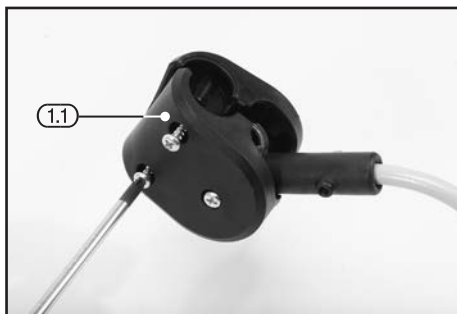

FIG.15



FIG.16

8. PREPARING THE LAWN AERATOR/SCARIFIER

- Fasten loose cables to the assembled handle sections using the cable clips (19) (fig.19).



FIG.17



FIG.18

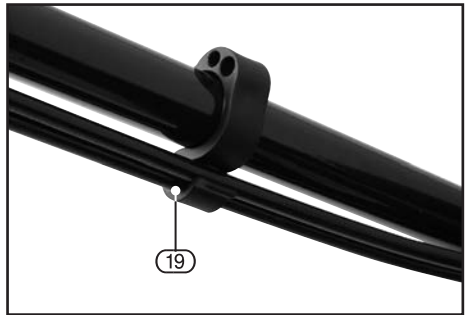

FIG.19

8. PREPARING THE LAWN AERATOR/SCARIFIER

8.5 ASSEMBLING THE COLLECTION BAG – FIGS.20 – 23

Warning! Always ensure that the motor is switched off with the plug removed from the wall.

The grass collector can be used with both aerator and scarifier function. To assemble:

- Put collection bag (18) frame into mesh bag (9).
- Clip mesh bag at support hole.
- Lift machine back cover and locate collection box onto hooks.

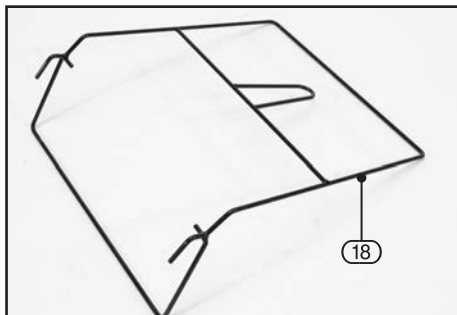

FIG.20



FIG.21



FIG.22



FIG.23

8. PREPARING THE LAWN AERATOR/SCARIFIER

8.6 INSERTING THE AERATOR/ SCARIFIER CARTRIDGES (97921/98931) – FIGS.24 – 27

Warning! Always ensure that the motor is switched off with the plug removed from the wall.

- Turn the machine upside down so the wheels are in the air.
- Unscrew the screws from the bearing (22).
- Lift up the bearing half.
- Lift the cartridge from the lower bearing half and pull it out from the drive side.
- To re-assemble, proceed in the reverse order.

Note: The aerator/scarifier comes set up with aerator cartridge in place. Follow above procedure to convert to scarifier.

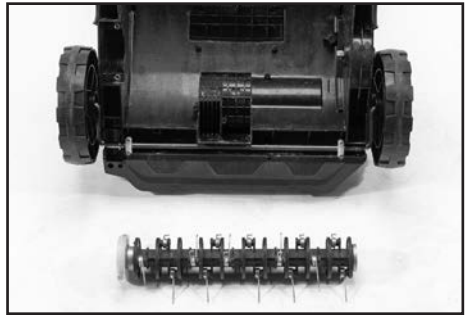

FIG.24

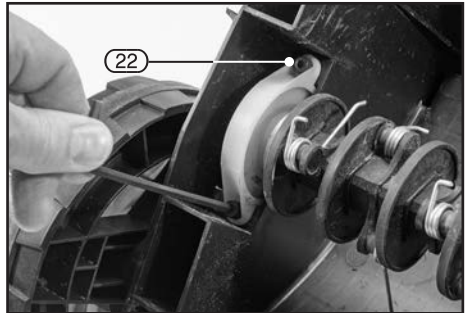

FIG.25



FIG.26



FIG.27

8. PREPARING THE LAWN AERATOR/SCARIFIER

8.7 INSERTING THE AERATOR/SCARIFIER CARTRIDGES (97922) – FIGS.28 – 31

Warning! Always ensure that the motor is switched off with the plug removed from the wall.

- Turn the machine upside down so the wheels are in the air.
- Unscrew the fastening bolt on the bearing (23).
- Lift up the bearing half.
- Lift the cartridge from the lower bearing half and pull it out from the drive side.
- To re-assemble, proceed in the reverse order.

Note: The aerator/scarifier comes set up with aerator cartridge in place. Follow above procedure to convert to scarifier.

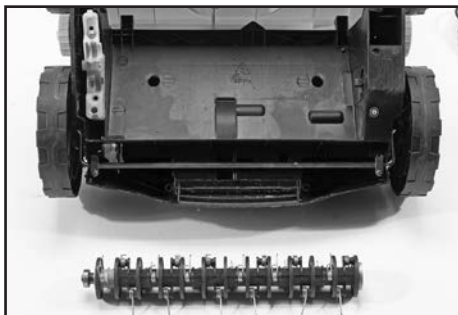

FIG.28

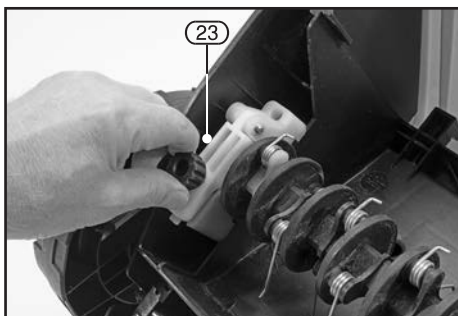

FIG.29



FIG.30



FIG.31

9. OPERATION

9.1 WORKING HEIGHT – FIGS. 32 – 33

Warning! Always ensure that the motor is switched off with the plug removed from the wall.

The scarifying depth is set using the depth adjustment on the two front wheels.

Gently pull the depth adjustment lever (6) and latch into the desired positions as shown below:

97921/98931

| Position | Aerator cartridge | Scarifying cartridge |
|----------|-------------------|----------------------|
| 1 | x | -12mm |
| 2 | x | -8mm |
| 3 | -4mm | -4mm |
| 4 | +4mm | +4mm |

97922

| Position | Aerator cartridge | Scarifying cartridge |
|----------|-------------------|----------------------|
| 0 | 6mm | 6mm |
| 1 | -3mm | -3mm |
| 2 | -6mm | -6mm |
| 3 | -9mm | -9mm |
| 4 | -12mm | -12mm |

9.2 SWITCHING ON AND OFF – FIGS. 34 – 35

Press the safety button (1.2) and at the same time squeeze the trigger (1.3). The motor will start. Now release the safety on button but continue to squeeze the trigger.

As soon as the trigger is released, the motor will stop.



Warning! Use of this product can pose a danger to wildlife. Before attempting to use this product, check the surrounding area, particularly long grass and under bushes, for signs of life and relocate if necessary.

Note: Not all animals will be deterred by the noise of the product alone.



FIG.32



FIG.33



FIG.34



FIG.35

10. MAINTENANCE AND TROUBLESHOOTING

10.1 MAINTENANCE

Regular inspection and cleaning reduces the necessity for maintenance operations and will keep your tool in good working condition.

The motor must be correctly ventilated during tool operation. Avoid blocking the air inlets and vacuum the ventilation slots regularly.

10.2 TROUBLESHOOTING GUIDE

| Problem | Possible Cause | Remedy |
|---|--------------------------|---|
| Motor does not start. | 1. Housing clogged. | 1. Adjust working depth and clean housing so that the roller runs freely. |
| | 2. Unsure. | 2. Return to an authorised service agent for diagnosis. |
| Engine performance drops. | 1. Soil is too firm. | 1. Change working depth. |
| | 2. Housing clogged. | 2. Adjust working depth and clean housing so that the roller runs freely. |
| | 3. Roller badly worn. | 3. Replace roller. |
| Imprecise scarifying result | 1. Roller badly worn. | 1. Replace roller. |
| | 2. Wrong working depth. | 2. Correct working depth. |
| Motor is running, roller is not rotating. | 3. Toothed belt is torn. | 3. Return to an authorised service agent for replacement belt. |

11. DISPOSAL

11.1 DISPOSAL

- At the end of the machine's working life, or when it can no longer be repaired, ensure that it is disposed of according to national regulations.
- Contact your local authority for details of collection schemes in your area.

In all circumstances:

- Do not dispose of power tools with domestic waste.
- Do not incinerate.
- Do not dispose of WEEE* as unsorted municipal waste.



* *Waste Electrical & Electronic Equipment.*

12. EXPLANATION OF SYMBOLS

12.1 EXPLANATION OF SYMBOLS



Read the instruction manual.



Wear face mask and safety glasses.



Wear ear defenders.



Wear suitable protective footwear.



Warning!



Warning! Keep bystanders away.



Warning! Keep bystanders away.



Warning! Keep out of the reach of children.



Warning! Danger to wildlife.



Warning! Blades may still spin after switching off.



Warning! Danger of crush injury.



Warning! Danger of foot injury.



Class II construction (Double insulated).



WEEE – Waste Electrical & Electronic Equipment.
Do not dispose of Waste Electrical & Electronic Equipment in with domestic rubbish.



Continuous A-Weighted Sound Pressure Level.



Water ingress protection rating.

CONTACTS

Draper Tools Limited, Hursley Road,
Chandler's Ford, Eastleigh, Hampshire. SO53 1YF. UK

Delta International, Delta International BV,
Oude Graaf 8, 6002 NL, Weert, Netherlands

Help Line: (023) 8049 4344

Sales Desk: (023) 8049 4333

Internet: drapertools.com

E-mail: sales@drapertools.com

General Enquiries: (023) 8026 6355

Service/Warranty Repair Agent:

For aftersales servicing or warranty repairs, please contact the
Draper Tools Help Line for details of an agent in your local area.

YOUR DRAPER STOCKIST